

ARL-9000

Automated Radiosonde Launcher



Installation and User Guide

Version 1.22

ARL-9000 Automated Radiosonde Launcher

Rev. F

1/7/2008

www.yesinc.com

Copyright © 2003-2008 Yankee Environmental Systems, Inc. All rights reserved.
The information in this document is subject to change without notice. Company and product names used herein may be the trademarks or registered trademarks of their respective companies.

Yankee Environmental Systems, Inc.
Airport Industrial Park
101 Industrial Blvd.
Turners Falls, MA 01376 USA

Phone: 413-863-0200
FAX: 413-863-0255
E-mail: info@yesinc.com
web: www.yesinc.com

Contents

1	Introduction	1-1
	<i>Mechanical Configurations</i>	1-3
	Specifications.....	1-6
	Principle of Operation.....	1-11
	<i>System Architecture</i>	1-13
	<i>System Data Interfaces</i>	1-14
	<i>Electrical Power Requirements</i>	1-15
	<i>Development History and Background</i>	1-15
2	Installing and Loading the System.....	2-1
	Selecting a Site.....	2-2
	Unpacking and Mechanical Assembly.....	2-3
	<i>Antenna Mounting</i>	2-5
	Making Electrical Connections.....	2-7
	<i>General Wiring Considerations</i>	2-7
	<i>Using Portable Generators for Mobile Operation</i>	2-8
	<i>Connecting to Earth Ground</i>	2-8
	Making Communications Connections.....	2-9
	Making Lifting Gas Connections.....	2-10
	System Preliminary Testing.....	2-12
	<i>Testing the CPU Hardware</i>	2-13
3	Launching Radiosondes.....	3-1
	Getting Familiar with the Hardware	3-2
	<i>Radiosonde Preparation</i>	3-2
	<i>Balloon Preparation</i>	3-2
	Conducting Radiosonde Launches.....	3-7
	<i>Inflating the Balloon</i>	3-7
	Database Access via ODBC, JDBC, DBI.....	3-9
	Managing YESDAQ Database Accounts	3-10
	<i>Creating New User Accounts</i>	3-11

<i>Changing User Accounts</i>	3-12
<i>Removing User Accounts</i>	3-12
<i>Using Open Database Connectivity Drivers</i>	3-1
<i>Using ODBC drivers with the Macintosh OS</i>	3-2
<i>Using Java Database Connectivity drivers</i>	3-2
<i>Using the Perl Database Interface</i>	3-3
<i>Support for other Programming Environments</i>	3-3
4 Maintenance and Troubleshooting	4-1
Routine Maintenance	4-2
High Pressure Gas Safety Guidelines	4-3
<i>Pressure Hazards</i>	4-3
<i>Identification, Signs, and Labels</i>	4-3
<i>Obtaining and Purchasing Cylinders</i>	4-4
<i>Handling and Use Securing the Cylinder</i>	4-4
<i>Cylinder Valves, Regulators, or Other Fittings</i>	4-4
<i>Opening and Closing Cylinders</i>	4-5
<i>Testing for Leaks</i>	4-5
<i>Testing Cylinders</i>	4-5
Things to Avoid With High Pressure Gas Cylinders	4-6
Solving Power Problems.....	4-7
Specialized Service	4-8
<i>Returning Line Replaceable Units for Factory Service</i>	4-8
<i>Upgrading the CPU system firmware</i>	4-8
<i>Replacing the Roof Motor LRU</i>	4-9
Packing for Shipment.....	4-10
Important Product Safety and Disclaimer Information.....	4-11
Product Warranty	4-12
Documentation Feedback	4-13

Table of Figures

Figure 1. The Model BILS-9400 system supports very high altitude synoptic soundings or heavy balloons requiring sounding balloons up to 800g.	1-3
Figure 2. Model 9001 trailer-mounted system for mobile operations.	1-3
Figure 3. ARL-9000 Mechanical Interface Drawing. The Model ARL-9001, adds a wheeled trailer to the ARL-9000 for mobile or tactical operation.	1-4
Figure 4. BILS-9400 Mechanical Interface Drawing. The larger inflation area and roof size permits launching balloons up to 800g.	1-5
Figure 5. Inside rack-mounted METHUB Meteorological Data Receiver.	1-7
Figure 6. Skew-T chart with high-resolution data from wind finding radiosonde launched from the ARL.	1-8
Figure 7. Linear Pressure, temperature, humidity (PTU) graph.	1-8
Figure 8. Typical text display of early flight, upper air sounding data.	1-9
Figure 9. Launch sequence for an automated launch.	1-10
Figure 10. Sounding balloon and radiosonde “train” in free flight just after launch.	1-11
Figure 11. Comparison of legacy analog radiosonde (left) showing basic components, to lightweight Model XDR-928 GPS digital radiosonde (right)	1-13
Figure 12. Internal system block diagram. Main embedded controller is at center, and up to eight fiber optic-linked satellite modules at right on Model ARL-9000/9001 (Model BILS-9400 has one satellite module for semi-auto operation).	1-14
Figure 13. ARL-9000 Installation with telemetry antenna.	1-15
Figure 14. Optimized system position relative to prevailing winds.	2-2
Figure 15. Crane lifting the ARL-9000 onto a roof.	2-3
Figure 16. Roof bolts secure roof during shipping and movement.	2-3
Figure 17. Wind sensor mast is attached to the ARL with two bolts.	2-4

Figure 18. A lock screw under the wind vane direction boot (left), permits alignment with north. A co-located anemometer (right) measures wind speed.	2-4
Figure 19. Aligning the wind direction sensor to geographical north.	2-4
Figure 20. System 403 MHz RF telemetry down link antenna. The mast can be manually turned in the direction of the upper air winds to maximize long range downwind telemetry reception. Note weather head entrance for coax on roof.....	2-6
Figure 21. Cable entrance for AC power, helium gas line and PTU-2000 cables. SO-type cord or waterproof flexible PVC conduit can be used for AC power.	2-7
Figure 22. System communications layout.	2-9
Figure 23. Helium Main Shutoff (left), regulator (center) and tank shut off (right).	2-10
Figure 24. Master Power Box located on inside wall of system inflation area. Main AC input is yellow plug at right, four non-GFCI convenience outlets are provided.	2-12
Figure 25. Main control board, located inside electronics enclosure.....	2-13
Figure 26. ALEX is used to exercise each control function.	2-13
Figure 27. Radiosonde on shelf (door is already open).	2-14
Figure 28. Cutter/valve assembly returned to the floor and ready for helium delivery test (no unwinder attached.).....	2-14
Figure 29. XDR-928 Radiosonde.	3-2
Figure 30. Expendable balloon components include the sounding balloon, gas check valve, and ≈12” (25 cm) piece of ¼” (6.4 mm) ID PVC tubing.....	3-3
Figure 31. Connecting the helium delivery tubing to the check valve.	3-3
Figure 32. Inserting the check valve holder into the balloon neck.	3-4
Figure 33. Completed check valve assembly.....	3-4
Figure 34. Balloon with completed check valve assembly and cable tie.....	3-4
Figure 35. Cutter placed back in launch position.	3-5
Figure 36. Unwinder is placed through cable tie at balloon neck.....	3-5
Figure 37. Completed balloon assembly with cable tie trimmed, ready for inflation.....	3-5

Figure 38. Tubing fed through cutter and attached to helium supply valve. Do not lift the satellite module up as far as shown or damage to the hinge will result!	3-6
Figure 39. ALEX Software. Sonde activate/fill/launch controls are at right; real time ground truth PTU+Wind data is at right.	3-7
Figure 40. YESDAQ DVE World View; click on your location to drill down to data.....	3-8
Figure 41 Viewing User/Agent Accounts.....	3-10
Figure 42 New User Account	3-11
Figure 43 Password Dialog.....	3-12
Figure 44 ODBC Data Source Administrator.....	3-2

In This Manual

This manual explains how to install and use the ARL-9000 Automated Radiosonde Launcher, the ARL-9001 Mobile Automated Radiosonde Launcher as well as the BILS-9400 Balloon Inflation and Launch Shelter.

Because of their similarities, only differences between the models will be noted in this manual.

This manual covers the following topics:

CHAPTER	CONTENTS	
1	Introduction	Overview of the system and specifications
2	Installing and Loading the System	Installation and loading expendables
3	Launching Radiosondes	Automated and manual launch procedures
4	Maintenance and Troubleshooting	Routine maintenance procedures and things to try if a problem occurs

Below are several related documents useful for the 9000/9001 system:

- *YESDAQ User Guide*
- *PTU-2000 Thermohygrometer Installation and User Guide*

If you have a question about using the system and cannot find the answer you need in this manual, contact YES Technical Support using any of the following methods:

- **E-mail:** support@yesinc.com
- **Web:** www.yesinc.com (see the *Support* section)
- **Fax:** +1-413-863-0255

What this manual covers

Related manuals

Technical support



Warning: Please read this manual before using your system, especially Important Product Safety and Disclaimer Information in page 4-11. Because the system roof and gas flexible tubing cutters can start moving at any time, it should only be installed out of the reach of unauthorized personnel. Never operate the system within the reach of young children while they are unattended and be sure to keep your hands and fingers clear of the moving components while powered on.

CHAPTER 1

Introduction

The Model ARL-9000 Automated Radiosonde Launcher system provides automated and semi-automated unattended upper air observations. It is ideal for weather observations at remote manpower-limited operations, meteorological research stations or for temporary emergency weather support. The Model BILS-9400 is very similar to the ARL-9000 system but only inflates and releases radiosondes remotely.

Radiosonde soundings, or *upper air* observations, have long been used in weather forecasting. Recently, pressure temperature humidity and wind data (PTU+wind) from soundings feed initial conditions in numerical weather prediction models. The system takes a manually intensive task of inflating a radiosonde balloon and releasing it and reduces it to a periodic maintenance routine. Because every step is automated, it frees personnel to perform more important, value-added tasks. It also keeps people out of potentially dangerous weather, and greatly reduces human errors.

Upper air observation sites are typically spaced hundreds of kilometers apart and available upper air data may not be representative of your location. The ARL-9000 is ideal where vertical profiles of pressure, temperature, humidity, and winds are needed on a routine basis. This includes field programs, severe weather augmentation, university research, and emergency management.

Depending on the desired launch frequency, operators visit the system to load expendables, however, they are not required to be present to launch a radiosonde. This is an important consideration in remote areas or hazardous weather conditions. The system is completely automated for preset release times or can be remotely controlled to capture rapidly changing weather conditions. The system performs a number of functions, including:

The Launch Process

- Powers up a loaded GPS radiosonde either on demand or at an allotted time
- Verifies the RF link to the radiosonde (this checks battery)
- Checks the wind speed to verify it is low enough for a successful launch
- Activates fan aspiration to equilibrate the outside air with the radiosonde(s)
- Performs a QC verification of radiosonde data against real time Pressure Temperature and Humidity (PTU) via a nearby YES Model PTU-2000
- Inflates the balloon and verifies inflation produced required buoyancy
- Opens the roof and releases the balloon/sonde package, and verifies payload is successfully away
- Continuously captures the data for duration of the sounding flight in a database

- Returns to idle state and prepares for next launch

There are numerous applications for automated upper air systems:

Applications

- Operational Numerical Weather Prediction: Upper air observing system for commercial and military applications, providing input for weather forecast models.
- Fixed or Tactical Use: Permanent or mobile applications such as wildland fire or military
- Remote Sensing: Ground truth validation for calibration of satellite platforms
- Scientific Research: Global warming and climate change, the mobile ARL-9001 version is ideal for field experiments
- Limited space: Compact footprint
- Labor Reduction: Replacement of human operators at remote or hostile locations

The mobile ARL-9001 version is a trailer-mounted Model ARL-9000 with tank rack and complements fixed upper air networks, filling in spatial gaps for mesoscale numerical prediction models. The larger Model BILS-9400 system supports either manual or semi-automated single launches of single balloons 800g in size. The BILS can be augmented with a radiosonde ground support system that supports YES Model XDR-928 radiosondes, or it can be used to release radiosondes made by other manufacturers. The BILS-9400 is large enough to accommodate synoptic-size very large sounding balloons the US National Weather Services and other Met Offices use to reaching extremely high altitudes (>100,000').

Other Models

The physically larger BILS-9400 can sometimes accommodate slightly larger balloons if they are elongated when inflated. Larger balloons support carrying special payloads such as radar reflectors. For portable emergency or tactical military weather applications, both the BILS and ARL can be setup as truck-mounted systems, referred to as the *Meteorological Emergency Response Vehicle*, or MERV.

Mobile upper air systems provide a turnkey solution and are ideal for applications covering wildland fire support, HAZMAT emergency response, military force protection and homeland security/homeland defense. In the event of a nuclear, chemical or biological attack, these systems can be moved into position rapidly and can be deployed by a single person, policeman or firefighter to obtain crucial upper air winds. Such data is used to drive plume dispersion models as in the YES *Weather Web Minuteman™* system.

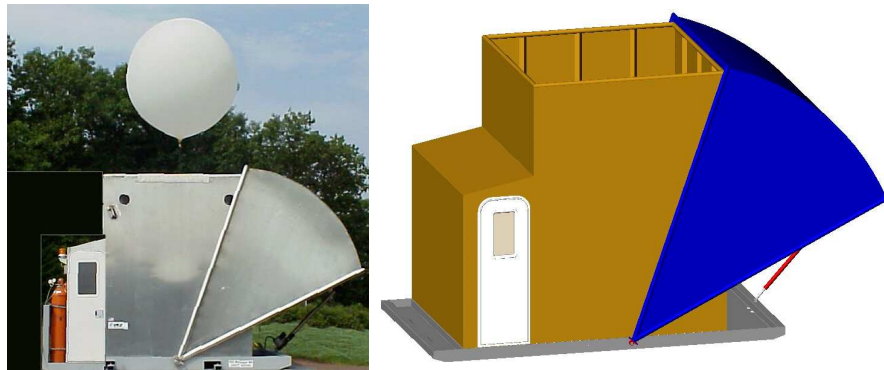

Figure 1. The Model BILS-9400 system supports very high altitude synoptic soundings or heavy balloons requiring sounding balloons up to 800g.

Mechanical Configurations

To address application-specific requirements, the following models are available:

- Model ARL-9000 supports “fixed base” permanent sites (see Figure 3 and cover)
- Model ARL-9001 mobile trailer-mounted ARL supports temporary deployment for military or emergency management weather operations (see in Figure 2);
- Model BILS-9400 Balloon Inflation and Launch Shelters (BILS) obtain high altitude synoptic soundings with 800g balloons (see Figure 1 and Figure 4).
- Truck mounted systems are referred to as “Mobile Emergency Response Vehicles” or MERVs



Figure 2. Model 9001 trailer-mounted system for mobile operations.

The ARL-9000/9001 provide support for most meteorological applications as it supports sounding balloons up to 600g. For applications requiring very high altitude soundings or large payloads, the BILS-9400 supports 800g sounding balloons.

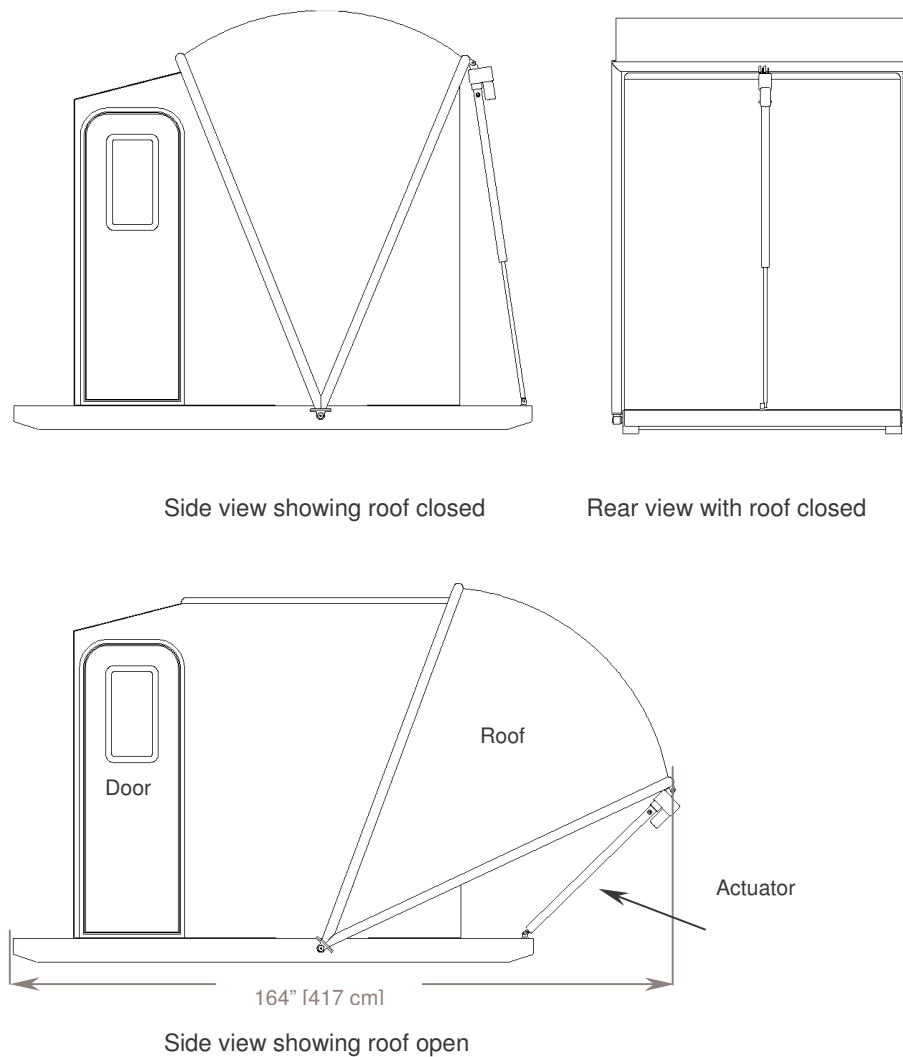

Figure 3. ARL-9000 Mechanical Interface Drawing. The Model ARL-9001, adds a wheeled trailer to the ARL-9000 for mobile or tactical operation.

The BILS-9400 Mechanical Interface Drawing appears on the following page.

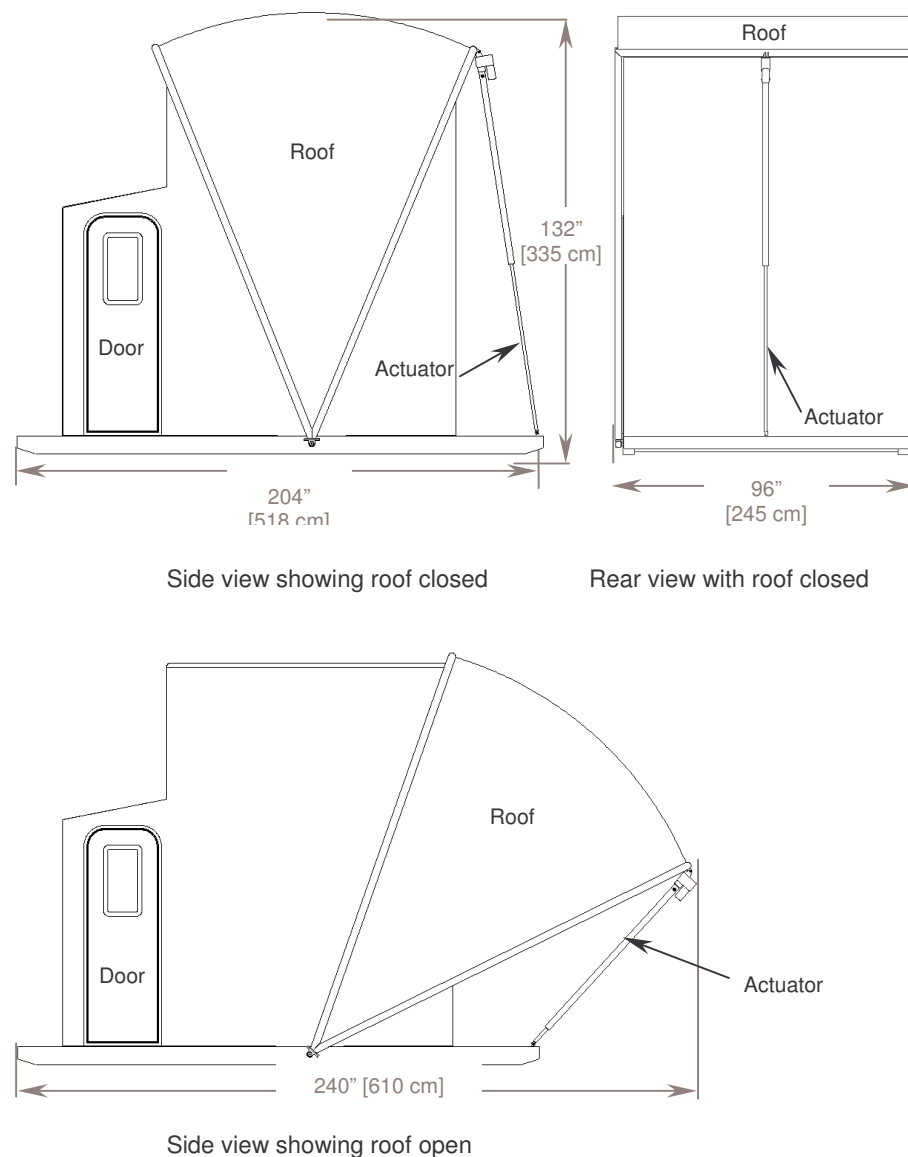

Figure 4. BILS-9400 Mechanical Interface Drawing. The larger inflation area and roof size permits launching balloons up to 800g.

The BILS-9400 is typically used to inflate and release single radiosondes in semi-automatic mode (i.e. remotely controlled by a human operator). It is modeled after the US National Weather Service's High Bay Inflation Shelters that have been in use since the 1960s.

Note: The ARL9000 is made using integrated welded aluminum “unibody” construction techniques. The physically larger Model BILS-9400 is made from prefabricated panels that are bolted together on site. Due to its height, the BILS-9400 is not readily transported over road when fully assembled, unless “low boy” flatbed semi tractor-trailers are used. Ensure adequate bridge clearance when transporting BILS-9400 systems (a minimum of 14’) over the entire driving route - rural routes tend to have lower bridge heights, so plan accordingly. The ARL-9000’s lower overall height provides more compatible system for rural areas.

Specifications

CHARACTERISTIC	DESCRIPTION
ARL-9000 Dimensions	Length (roof closed): 8 ft (2.4 m) Length (roof open): 11 ft (3.4 m); 8' for ARL-9001 Width: 6.5 ft (2.0 m); 8' for ARL-9001 Height: 8 ft (2.4 m); 11' for ARL-9001
ARL-9000 Weight	≈3220 lbs. (1460 kg)
BILS-9400 Dimensions	Length (roof closed): 17 ft (5.2 m) Length (roof open): 20 ft (6.1 m) Width: 8 ft (2.4 m) Height: 11 ft (3.4 m)
BILS-9400 Weight	≈ 4300 lbs. (1814 kg)
Power requirement	110/220 Vac 50/60 Hz, 30A (1A typical)
Environmental temperature range	-40°C to +44°C
Launch wind speed limits	≤ 45 mph (20 ms ⁻¹)

Software

The system software runs on a METHUB Meteorological Data Receiver, which stores sounding data internally in YESDAQ. YESDAQ is a MySQL-based database providing web and ODBC/JDBC data connectivity to downstream user applications such as numerical weather prediction (NWP) tools. The Automated Launch Executive (ALEX) application manages launches via your MS-Windows PC.

YESDAQ provides multiple users with web access to upper air data, and once the system is loaded with expendables, it can be fully remotely controlled (e.g. users can control the release of a balloon for compliance with Air Traffic Control/controlled airspace regulations.) The software architecture also permits any number of remote upper air sites to be centrally monitored and controlled, supporting:

- Schedule-driven launches
- Relational database storage of all upper air sounding data
- Web-based visual display interface to database, as well as ODBC/JDBC
- Logs for coordinating expendable refilling and system maintenance

Hardware

Radiosondes and expendables including helium gas, batteries, and up to 600g balloons are loaded into a ARL-9000 or up to 800g or larger balloons with a BILS-9400. Each “channel” manages a single radiosonde and the balloon inflation process and battery activation. The ARL-9001 system’s trailer provides “go-anywhere” operation for emergency response or research use.

METHUB Data Receiver

The METHUB *Meteorological Data Receiver* is rack-mounted and is typically located near the launcher in an indoor, weather-protected location. The PC-based *Automated Launch EXecutive* (ALEX) software interacts with the METHUB via TCP/IP networking, usually via a 802.3 wired or 802.11 wireless LAN. The graphical ALEX application controls the actual launch sequence.



Figure 5. Inside rack-mounted METHUB Meteorological Data Receiver.

METHUB stores upper air data in a YESDAQ database. Once upper air telemetry data are received and stored, the *Data Visualization Engine* (DVE), provides web access to users to sounding data in a variety of formats:

- Fully interactive Skew-T Meteorological chart with zoom (see Figure 6)
- Linear Pressure, Temperature, Humidity (PTU) graph (see Figure 7)
- Text frame with calibrated data (see Figure 8)

Skew-T Chart from YESDAQ DVE

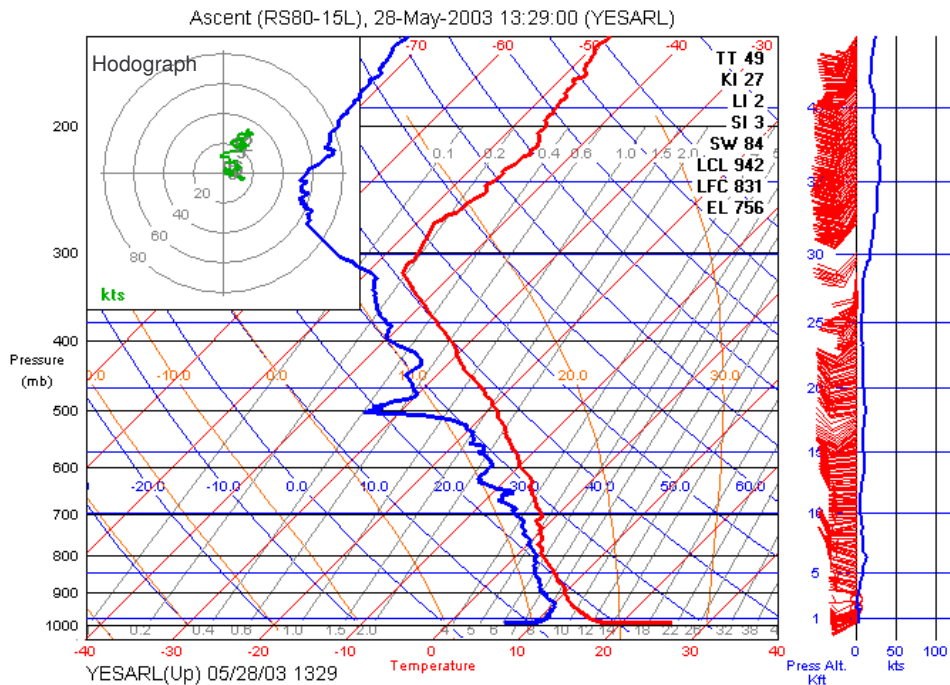

Figure 6. Skew-T chart with high-resolution data from wind finding radiosonde launched from the ARL.

The Skew-T chart is based on a NWS java applet that loads into any web browser.

PTU Chart from YESDAQ DVE

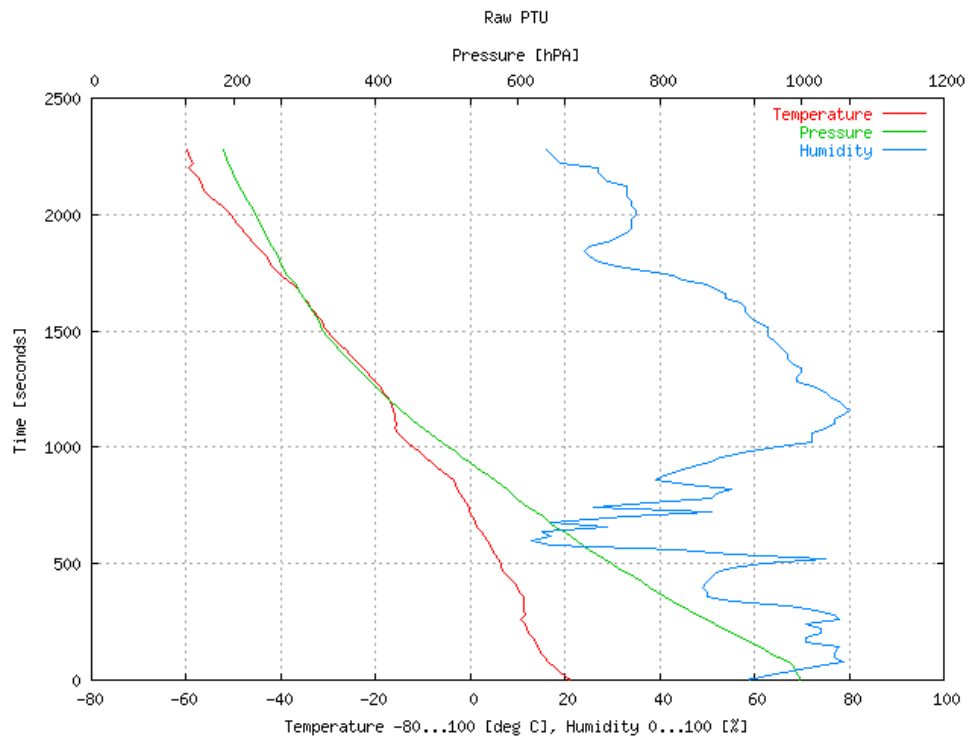

Figure 7. Linear Pressure, temperature, humidity (PTU) graph.

Managing a network of multiple upper air sites over time produces a sizable data repository. The DVE's initial *World View* provides rapid access to individual sites. Upper air data are collected and stored for later web display or further analysis in YESDAQ, a MySQL-based open source relational database with ODBC/JDBC data

connectivity. Event data permits site quality control, and facilitates fleet maintenance procedures.

Text Data from YESDAQ DVE

```

YESARL(Up) 05/28/03 1329
Ascent (RS80-15L), 28-May-2003 13:29:00 (YESARL)

TT = 49.0 KI = 27.0 LI = 2.0 SI = 3.0 SW = 84.0
LCL = 942.0 LFC = 831.0 EL = 756.0

P_alt   mb      t/td     w_dir/w_spd
(ft)                (°C)      (kts)

  328  993  25.4/10.00   240°/004
  328  993  25.6/10.30   240°/004
  331  993  25.6/10.30   240°/004
  348  992  22.4/7.700   240°/004
  381  991  20.0/6.400   240°/004
  397  991  18.0/7.800   243°/004
  384  991  17.6/7.400   243°/004
  423  990  17.4/9.300   243°/004
  449  989  17.5/9.900   243°/004
  466  988  17.3/9.700   243°/004
  525  986  16.9/10.20   243°/004
  561  985  16.6/10.50   243°/004
  617  983  16.5/10.50   247°/004
  627  982  16.3/10.60   247°/004
  653  981  16.0/10.60   247°/004
  696  980  15.9/10.60   247°/004
  719  979  15.8/10.50   247°/004
  764  978  15.6/10.60   247°/004
  781  977  15.6/10.70   247°/004
  801  976  15.6/10.70   247°/004
  840  975  15.4/10.60   247°/004
  856  974  15.4/10.70   247°/004

```

Figure 8. Typical text display of early flight, upper air sounding data.

Automated launches are controlled via a sequence of computer-driven events as shown in Figure 9. Once the launch sequence is initiated, a series of commands are executed on the ARL controller system that controls all processes required to launch, include activating the radiosonde battery, inflating the balloon, opening the roof, cutting the gas line and closing the roof. The launch sequence is based on a decision tree with fault detection and event monitoring.

Launch Sequence

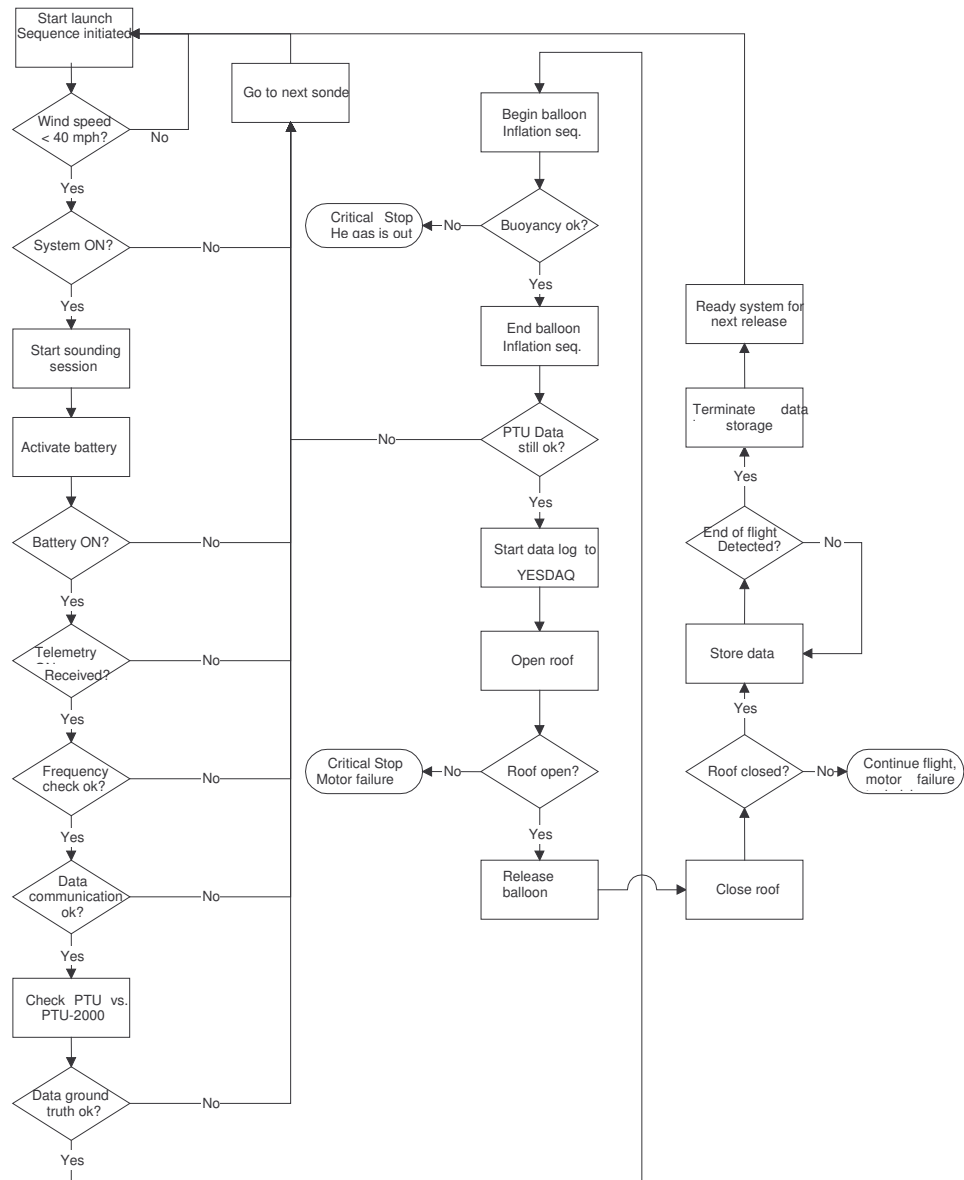

Figure 9. Launch sequence for an automated launch.

The details in the figure above vary depending on the actual Model, but it shows most of the key functions involved in launching a radiosonde and balloon.

Principle of Operation

The automation of upper air soundings requires a careful understanding of the failure modes of free-flight sounding balloons as well as radiosondes. An upper air sounding is defined as “A measurement of the vertical profile of the thermodynamic and kinematic state of the atmosphere.”¹ The radiosonde makes an *in situ* point measurement of the atmosphere that it passes through as it ascends on a 100 ft (30 m) tether attached to the sounding balloon. A sounding balloon is a free, unmanned balloon instrumented and/or observed for the purpose of obtaining a sounding of the atmosphere.

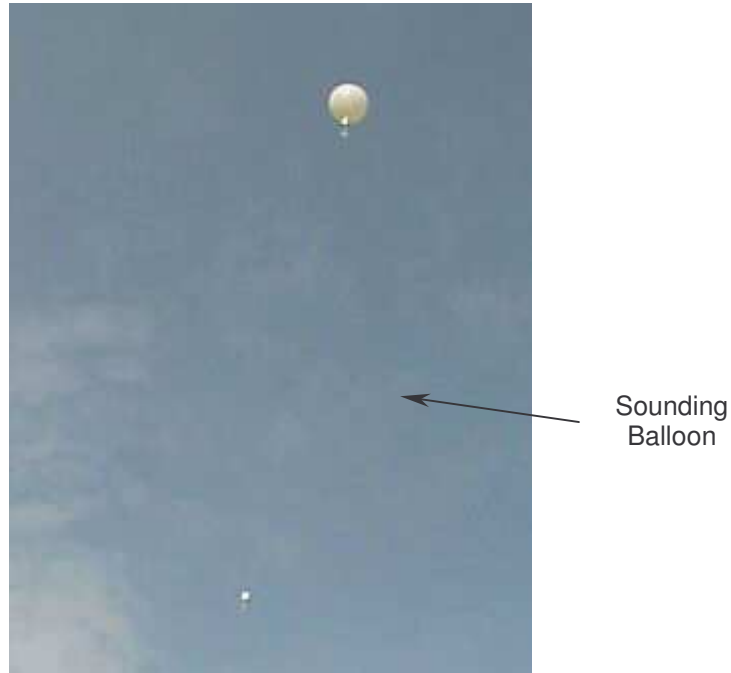

Figure 10. Sounding balloon and radiosonde “train” in free flight just after launch.

A radiosonde is an expendable meteorological instrument package that measures the vertical profiles of atmospheric variables from the surface to the stratosphere and transmits the data via radio to a ground receiving system. Typically, a SkewT Graph is used to plot temperature, dew point, wind speed and direction as a function of pressure. A hodograph display provides X/Y ground track history. Radiosonde

As the radiosonde rises at about 1,000 feet/minute (about 300 m/minute), sensors on the radiosonde measure profiles of pressure, temperature, and relative humidity. These sensors are linked to a battery powered, 300 mW radio transmitter that sends the sensor measurements to a sensitive ground receiver on a radio frequency at about 403 MHz. By tracking the position of the radiosonde in flight, information on wind speed and direction aloft is also obtained. Historically, these so-called “rawinsonde” observations were obtained by tracking a balloon-borne radiosonde using a radio direction finder. Later systems used Omega, then Loran-C radio-navigation technologies. The US launched a constellation of 24 Global Positioning System

¹ Glossary of Meteorology, American Meteorological Society, 2000

(GPS) satellites that are used for wind finding. In 2005 the European Union will launch a similar constellation.

Historically, radiosonde temperature sensors generally measured temperature-induced changes in the electrical resistance, capacitance, or voltage of a material. Similarly, humidity sensors respond to changes in ambient humidity or characteristics of air dependent on water vapor content. Pressure sensors were often mechanical aneroid cells, which flexed in proportion to pressure changes. Today, micro-machined sensors have replaced these methods. Some radiosondes do not measure pressure directly, but pressure data are calculated from the hypsometric equation using temperature, humidity, and height data by relating the thickness, h , between two isobaric surfaces to the mean temperature of the layer:

$$h = z_2 - z_1 = \frac{R\bar{T}}{g} \ln\left(\frac{p_1}{p_2}\right)$$

where z_1 and z_2 are geometric heights at pressure levels p_1 and p_2 , respectively; R is the gas constant for dry air; \bar{T} is the mean temperature of the layer; and g is gravity.

On occasion, with the ideal conditions radiosonde flights can last in excess of two hours. During this time the radiosonde can ascend to over 115,000 feet (about 35 km) and drift more than 125 miles (about 200 km) downwind from the release/launch point. During the flight, the radiosonde can be exposed to temperatures as cold as -90°C (-130°F) and an air pressure only few thousandths of what is found on the Earth's surface. When the balloon has expanded beyond its elastic limit and bursts (about 20 feet or 6 meters in diameter), sometimes a small parachute is used to slow the descent of the radiosonde, minimizing the potential danger to life and property. Modern radiosondes are lightweight (100g) and typically a parachute is not needed.

The ARL-9000 system eliminates the traditional manual processes involved with radiosonde deployment. It uses standard sounding balloons and a person is not required on-site to launch the balloon and radiosonde train. On the Models ARL-9000/9001, as many as eight radiosonde and balloons expendables can be pre-loaded and operators do not need to revisit until expendables are depleted.

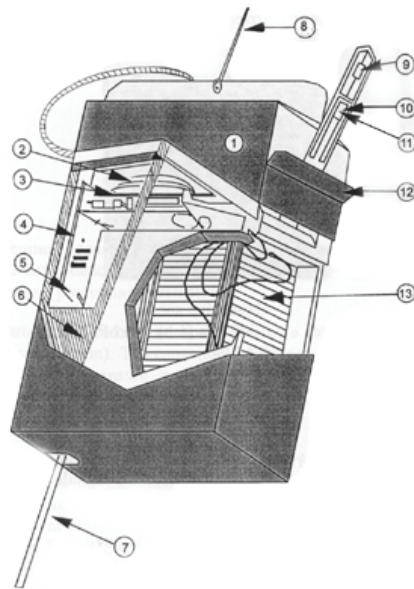

1. Insulation
2. Barometer
- 3/4. Electronics
- 5/6. Antenna gnd plane
7. Telemetry antenna
8. Tether string
9. Temperature sensor
10. Humidity sensor
11. Protective cap
12. Sensor support tab
13. Battery



Figure 11. Comparison of legacy analog radiosonde (left) showing basic components, to lightweight Model XDR-928 GPS digital radiosonde (right)

Once the system is loaded with expendables, it can automatically prepare and launch radiosondes on demand (semi-automatic) or at pre-determined intervals (automatic). At locations in most locations that are within controlled air spaces (e.g. near major airports), semi-automatic operation is usually mandated. Users interact with the system remotely via TCP/IP to launch at their discretion.

System Architecture

The ARL-9000/9001 system electronics enclosure contains system power supplies and a main controller linked to up to eight satellite actuator/sensor modules via a closed fiber optic network. The cluster of satellite modules together forms the *gas management module*. Each satellite module is powered by 12 Vdc and manages a single radiosonde and can be thought of as a “channel”. Once the radiosonde is loaded and armed, the module can activate the battery and initiation RF transmission

via a fiber optic connection to the radiosonde. The fiber optic connection to the radiosonde is a friction fit, loose enough to permit the connection to break free as lift off occurs just after release. Each satellite module also inflates the balloon with gas, via an electronic gas valve, and measures buoyancy via a magnetic sensor. As the balloon inflates the module is lifted upward on its spring hinge. When adequate buoyancy is achieved, the module lifts up enough to activate the magnetic switch. Finally, with the roof open, a servo operated knife cuts the gas line to release the balloon and radiosonde train.

The main CPU controller is linked to the METHUB Meteorological Data Receiver via a RS-232 serial data connection (see Figure 12). Models ARL-9000/9001 include eight satellite modules, a METHUB Meteorological Data Receiver and antenna. This provides a complete radiosonde ground system supporting both fully automated and semi-automated launches.

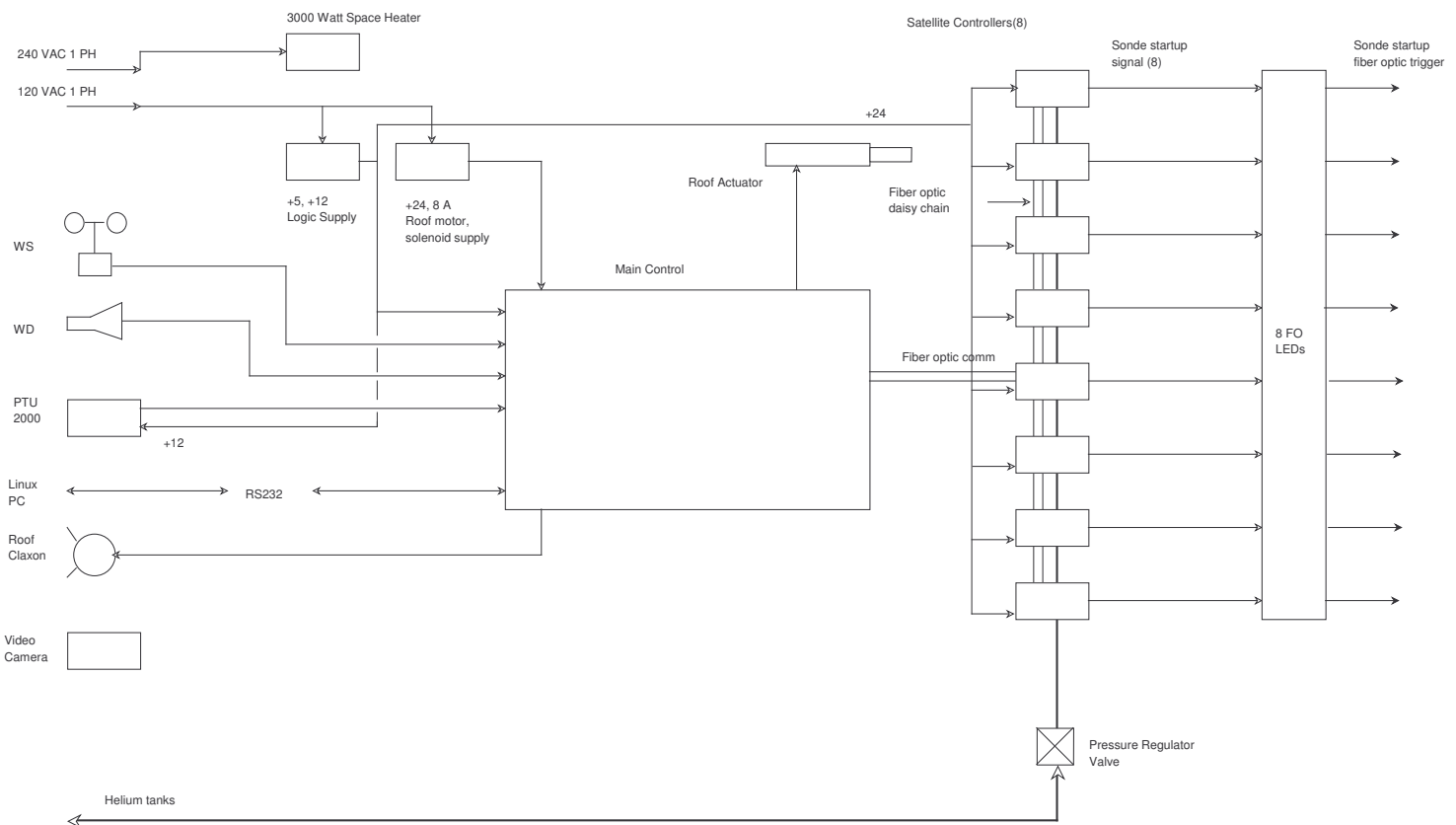

Figure 12. Internal system block diagram. Main embedded controller is at center, and up to eight fiber optic-linked satellite modules at right on Model ARL-9000/9001 (Model BILS-9400 has one satellite module for semi-auto operation).

System Data Interfaces

TCP/IP networking provides maximum flexibility and leverages your investment in existing communications infrastructure. Your upper air data is not locked up in a proprietary, commercial database—YESDAQ uses the open source [MySQL](#) database to store all sounding data. The primary operational interface with the system is via TCP/IP using a web browser and the YESDAQ *Data Visualization Engine*. Other databases or downstream applications can link to the YESDAQ database via ODBC

or JDBC drivers, or via the native MySQL Perl or C database interfaces. For more information on the MySQL support community visit www.mysql.com.

Electrical Power Requirements

The Models ARL-9000/9001 and BILS-9400 inflation enclosures can be heated and require 208-250 Vac, 50/60 Hz, however 110V is required if heaters are turned off, and DC battery operation is also possible using two marine/RV cells. With heaters on current draw is 20 Amps but drops to 1 Amp with heaters off. A fused disconnect switch is typically customer-provided via a separately protected branch circuit. The entire system disconnects via a twist lock L30 female plug.

Development History and Background

The YES Automated Radiosonde Launchers are a family of advanced-technology upper air systems, and were developed over an intensive multi-year R&D effort. It represents the first family of systems that are open, in that they can support other vendors' radiosondes and provides an alternative to manual upper air soundings. Core technology was developed for the US Department of Energy aimed at low-cost and highly reliable automated radiosonde launching. The Model ARL-9001 was developed for tactical mobile and emergency use for the US National Oceanic and Atmospheric Administration, aimed at forest fire weather and tactical defense support.

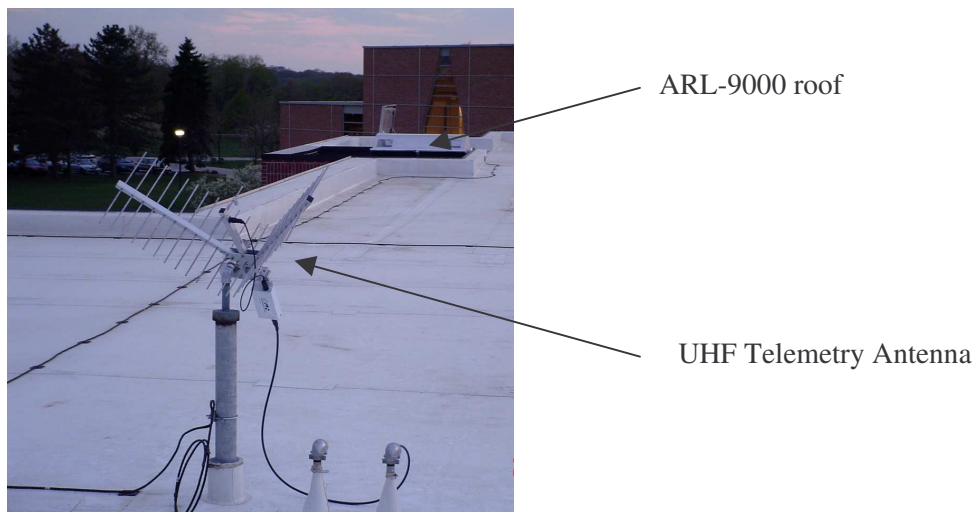

Figure 13. ARL-9000 Installation with telemetry antenna.

CHAPTER 2

Installing and Loading the System

Each system consists of:

- This *Installation and User Guide*
- The launcher enclosure with motor operated roof door
- 19" EIA Rack Mounted METHUB Meteorological Data Receiver
- RF corner Yagi antenna for radiosonde 403 MHz UHF telemetry
- Launch Executive Facility software for control of launches under MS-Windows
- Options for off-LAN use such as a wireless 802.11 hubs or a dialup modems for mobile or tactical use

Installation process

Apart from getting familiar with the system, the installation process consists of the following tasks:

- 1 Selecting an optimum site
- 2 Positioning the launcher into place
- 3 Removing the roof restraining bolts
- 4 Connecting to user's rented helium tanks or tank farm
- 5 Making necessary electrical and communications connections
- 6 Unpacking and assembling the RF antenna
- 7 Loading expendables and conducting a system test

This chapter describes each task.

Selecting a Site

Mechanical installation consists of five general tasks:

- 1 Selecting a site (whether permanent or temporary)
- 2 Connecting to AC power
- 3 Connecting to your helium gas supply plenum
- 4 Connecting to LAN via 10/100 Base T Ethernet
- 5 Mounting the METHUB Meteorological Data Receiver

The physical location you choose should be generally free of obstacles such as buildings, telephone poles, towers, etc. that might prevent the successful flight of the balloon and radiosonde during windy conditions. Remember, the windier the prevailing conditions tend to be, the farther the balloon will travel horizontally before clearing nearby structures. Make sure there is sufficient room for the roof to open and keep in mind the location of the antenna as discussed in the previous section.

The door should be on the leeward side of prevailing winds. Generally, the system is positioned with the door facing east and the roof opening towards the north. In this position, the thermohygrometer is also on the north side of the ARL, which minimizes solar radiation effects.

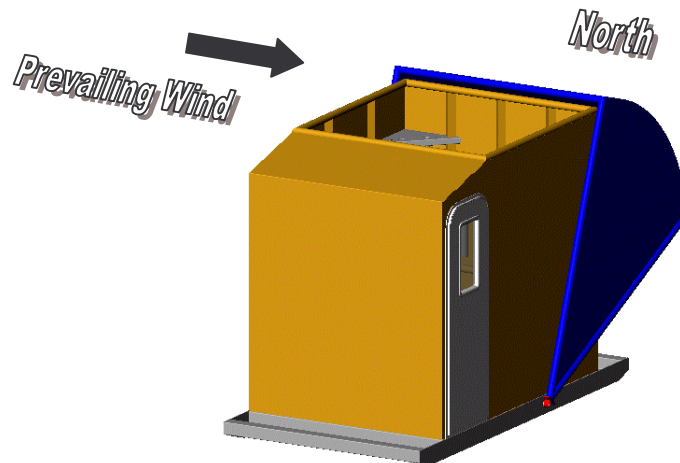

Figure 14. Optimized system position relative to prevailing winds

Warning: On the trailer-mounted Model ARL-9001, always chock the tires.

For permanent installations, you can set it on welded deck or a poured concrete pad. The system has significant area so toppling due to high winds is always a concern. Secure it to the mounting platform with high quality (SAE) ½” diameter or larger bolt hardware.

If the site is the roof of a building, follow all local codes for securing the system to the building structure and if possible, consult with a local structural engineer for approval. For safety during high wind conditions, it must be anchored to the frame of the building itself.

Unpacking and Mechanical Assembly

The system minimal assembly as many of the system components are assembled at the factory. A fork lift can be used to move the system or it can be craned into position. When using a crane to lift the system into position take care to use lifting straps as shown in Figure 15.



Figure 15. Crane lifting the ARL-9000 onto a roof.

Roof Bolts

Once the system is in position, before you operate the roof, remove the roof safety bolts, one on each side as shown in Figure 16. These bolts secure the roof and reduce strain on the Roof Motor Actuator during shipment or transport.

A YES Model PTU-2000 aspirated pressure/temperature/humidity sensor is used to ground check the radiosonde prior to release and is mounted in close proximity to the system and wired directly to the ARL controller. Mount the PTU-2000 on a suitable

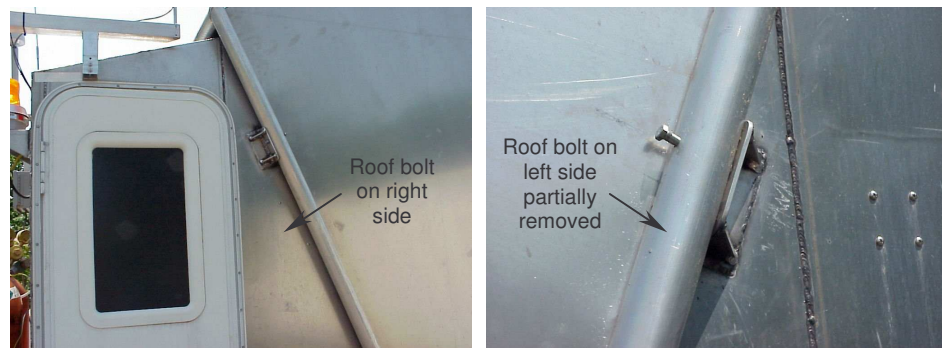

Figure 16. Roof bolts secure roof during shipping and movement.

PTU-2000 Installation

horizontal mechanical support, such as a hand railing or wall. Ideally, you want to mount the sensor away from any chimneys or heating or cooling (HVAC) equipment, or building vents that would artificially change the local air temperature. A pre-wired cable tethered to the launcher connects inside the PTU-2000's blower housing via Fast-ON connectors. Observe proper wire colors when connecting, then secure the PTU-2000 enclosure cap and seal with tape.

Note: This cable provides 12Vdc and a three wire serial data connection. See the *PTU-2000 User Guide* for more details on that sensor.

**Mounting
Surface Wind
Sensors**

The wind vane and anemometer provide pre-launch go/no go information and are mounted nearby or atop the system. Sounding balloons can be launched during sustained winds up to 45 mph (20 ms^{-1}), but the risk of a failure occurs as wind speed increases. Above these speeds chances increase for the balloon or radiosonde damaged during launch. The wind sensors are mounted just above the door and near

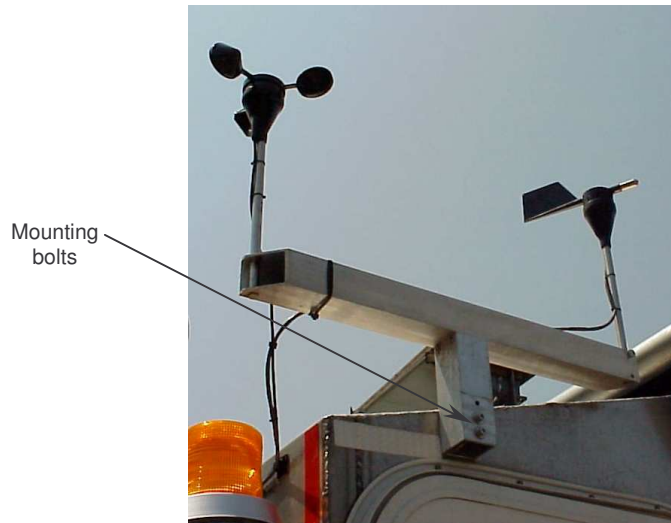

Figure 17. Wind sensor mast is attached to the ARL with two bolts.

the top of the roof but can be relocated if desired. The location needs to be sufficiently clear to avoid contact with the balloon and radiosonde train during launch. If necessary, relocate the wind sensor mast by removing the two $\frac{1}{4}$ -20 bolts



Figure 18. A lock screw under the wind vane direction boot (left), permits alignment with north. A co-located anemometer (right) measures wind speed.

that secure it to the system wall as seen in Figure 17.



Figure 19. Aligning the wind direction sensor to geographical north.

If the wind sensors are not already secured to the mast, you will need to insert both the anemometer and wind vane into the holes on the top of the mast mount. Secure each sensor mast to the mount with the #10 hardware and tie wiring to the mast with cable ties. Feed the cable into the inflation chamber via the cable entry strain relief provided near the mast left side. Attach the cables to the electronics enclosure inside the system. Finally, align the wind direction sensor north following the instructions above.

Note: On permanent installations, the wind direction sensor alignment only needs to be done once. For the mobile ARL-9001 system, you will need to align it each time you stop to make a sounding, in this case the lower mast thumb screw is more convenient.

Antenna Mounting

Next, you can install the telemetry data down link antenna, which consists of two general tasks:

- 1 Deciding where best to physically mount the antenna for optimal reception, with a dual goal of keeping clear of the balloon/radiosonde train.
- 2 Actually mounting it and connecting the coax to the METHUB data receiver.

The 400 MHz UHF corner-reflector Yagi telemetry antenna used with the METHUB must be roof mounted, and is typically located well away from the balloon exit path in the system. UHF radio signals are directional and behave similar to light, therefore, the antenna cannot be screened by large obstacles that absorb or reflect UHF radio energy, such as under trees or adjacent to large buildings or metal masts. Large metal structures cause multi-path reception interference. Even a nearby highway with moving 18 wheel trucks may at time hamper long range reception.

Caution: Unless you have the tools and experience, do not attempt to cut and splice the coaxial UHF cable to lengthen or shorten it. The coax is not compatible with CATV cable. Coil excess coax inside and tie it in a loop.

Ideally, the antenna should have a clear view of the sky down to the horizon in all anticipated upper air wind directions. If possible, place it upwind of the ARL-9000, based on typical prevailing surface winds at your site. By locating the antenna away from the launcher you help keep the balloon from getting punctured on the antenna. However, to maintain adequate signal-to-noise ratio, the antenna can't be located more than about 100' (30 meters) from the METHUB, a distance controlled limited by the coax cable length.

Note: On the mobile ARL-9001, the UHF telemetry antenna is mounted on a tripod near the system itself, and the antenna is packed inside the launcher for shipment. The antenna location must be chosen to provide free, unhindered ascent of the balloon and radiosonde train considering prevailing wind directions. Try to park the system such that the antenna is upwind, so as to reduce the chance that the balloon/radiosonde train might become entangled during exit. Also do not forget to align the wind sensor to local north

Telemetry Antenna Installation

Unpack the UHF telemetry antenna and note the RF-preamplifier enclosure below it. Secure the preamplifier output PL-259 connector to the coax cable and wrap the joint with the waterproof sealing tape provided. Use care not to let dirt get into the connector during assembly.

Next, using a U-bolt, secure the antenna mast to a suitable horizontal or vertical post at a 45° angle from vertical. Ideally, the mast will be snug but can slip such that you can manually redirect the antenna in the anticipated wind direction, which can have seasonal variation. As you use the system, you will want to, aim the telemetry

UHF
Preamp
Module



Figure 20. System 403 MHz RF telemetry down link antenna. The mast can be manually turned in the direction of the upper air winds to maximize long range downwind telemetry reception. Note weather head entrance for coax on roof.

antenna in the direction of prevailing upper air winds. Be sure the antenna mast is grounded to a building ground system or a nearby ground rod.

Making Electrical Connections

With physical installation complete, proceed to electrical hookup. Electrical installation consists of three general tasks:

- 1 Deciding how best to interface the system given your other equipment and overall data handling needs
- 2 Making the electrical connections
- 3 Testing the system end-to-end to verify all signals are correctly interpreted by your data management system and software

General Wiring Considerations

Plan ahead to have your electrician install a dedicated minimum 40 Amp circuit for 120 Vac, or 20A circuit for 220-250 Vac (preferred). The branch circuit needs a circuit breaker and an outdoor-rated, fused disconnect switch should be located next to the system. An outdoor fused disconnect typically used with HVAC equipment is ideal.

Note: Your system was pre-wired at the factory for your local line voltage. If you must change the line voltage, please contact YES Technical support for guidance via any of the methods in the section *In this manual* immediately following the *Table of Contents*.

Your system is an *active* electronic system and requires an electrically quiet, stable source AC power to operate properly. Provide a uninterruptible power supply (UPS) for the METHUB to an to ensure successful operation under all conditions.

Cable locations

The main power cord is routed through the wire conduit on the side of the launcher near the equipment rack and plugged into the waterproof outlet.

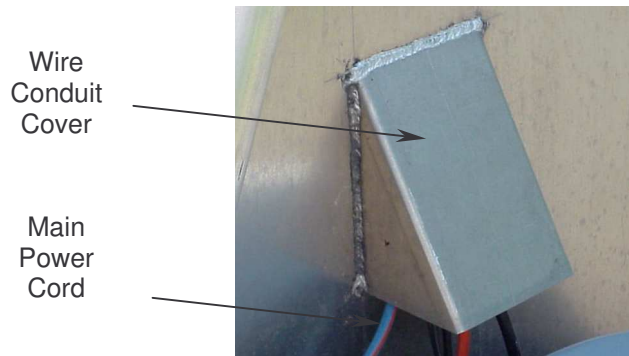

Figure 21. Cable entrance for AC power, helium gas line and PTU-2000 cables. SO-type cord or waterproof flexible PVC conduit can be used for AC power.

When connecting wires, keep in mind:

- Drape cables to create drain loops, keeping as far above the ground as practical.
- If you must lengthen cables, be sure to use heavy gauge wires to minimize voltage drop due to internal wire resistance. Be sure any cable splices are truly

watertight. Use RTV silicone sealant to properly seal any in-line cable splices. Corrosion builds rapidly if water penetrates a splice's weather seal.

Using Portable Generators for Mobile Operation

Off-grid operation

If you are not using commercial AC power and are conducting mobile operations, you can run the system from a good quality 10kW or larger generator. Be sure the generator is well-regulated and generates a pure *sine wave*, not a square wave. If the generator voltage is unstable or deviates from 50/60 Hz, the UPS will fail.

Note: If you are running on generator and are experiencing problems, deactivate the heater and provide a UPS. If the UPS will not power up, this indicates the voltage is out of frequency range, out of voltage range, or is electrically noisy. Many low cost AC generators are unregulated and not designed to run computers or switching supplies.

Because diesel, gas or propane AC generators emit soot, aerosols and other pollutants, it is extremely important that they be located as far away as possible from the system. Also, the generator should be located as far downwind as possible. Proper pre-flight aspiration of the radiosondes is essential.

Connecting to Earth Ground

Do not forget the Earth safety ground connection

To help prevent damage in the event of a lighting strike, *you must connect the system to a ground rod or cold water supply line*. Ideally, tie the ground wire to a copper-clad ground rod driven in the soil immediately next to the system. If installed on a roof, connect to a rooftop lightning rod system if one is available. If the rooftop has no lightning rod system, locate the closest copper cold water supply line. In very rocky soil areas or at mountain top sites, bury a radial pattern of eight ground wires around the sensor near the surface with top soil. Although a lot of work, do not skip properly grounding the system, as lightning can destroy the system and hurt or even kill operations personnel.



Caution: Connect the system chassis to a lighting rod system or a ground rod, not the AC third prong! If it is roof-mounted, ideally it should be tied into the building's lighting rod system by your lighting protection contractor. If the building does not have a lighting rod system, locate a copper cold water supply pipe and clamp several #6 AWG copper stranded wires between it and the system chassis.

Making Communications Connections

The System consists of three main components, the ARL itself with an internal embedded control system, the METHUB Meteorological Data Receiver, and your control PC running the Automated Launcher Executive software.

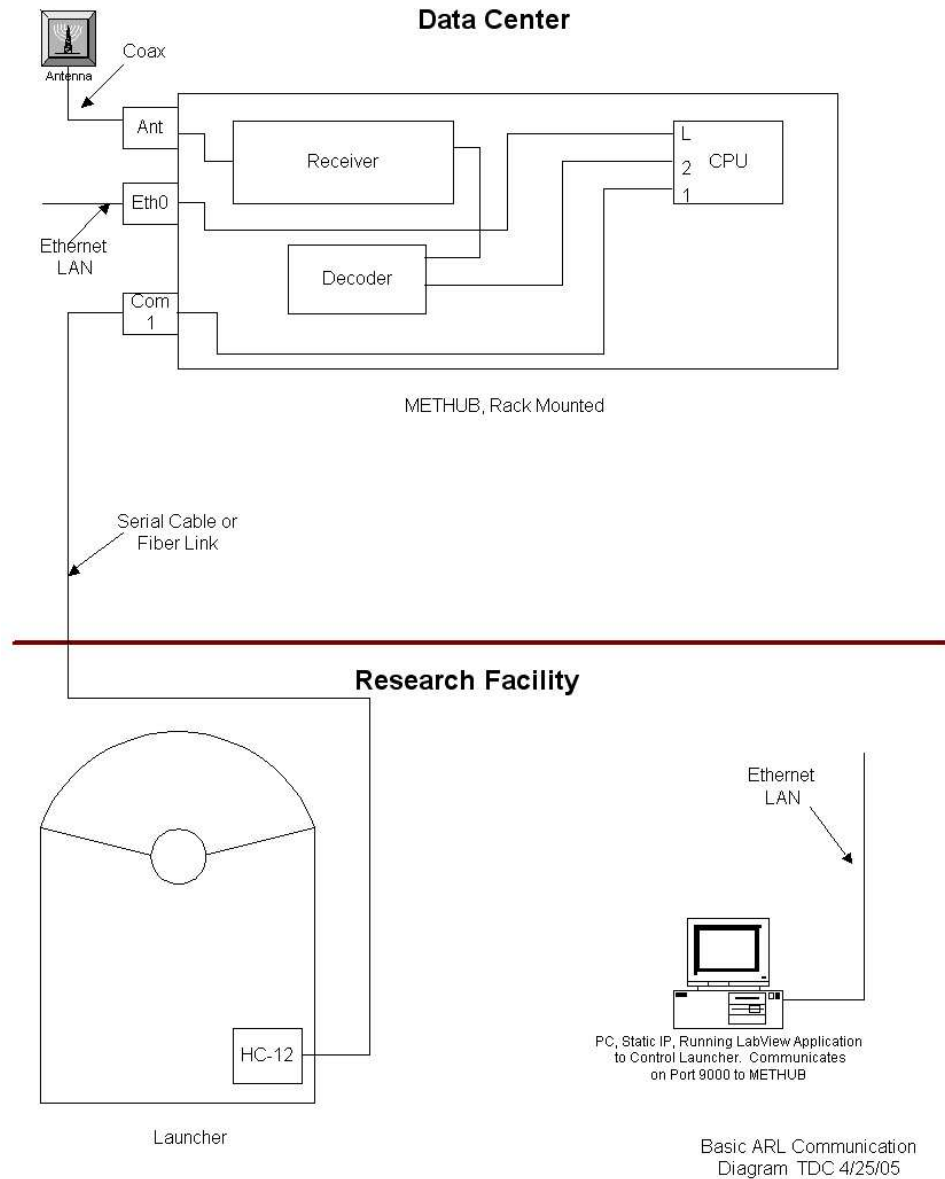

Figure 22. System communications layout.

The METHUB is physically located indoors and links via RS-232, RS-422 or fiber optic serial communications. The control PC can be located anywhere your LAN reaches, and can use 802.3 or 802.11 (WiFi) networking.

Making Lifting Gas Connections

The system requires lifting gas to inflate balloons and you need to plan carefully the logistics of the gas delivery. Typically 130 lb. commercial grade helium gas cylinders you rent locally from a welding gas supplier (such as Merriam Graves), are used. You can also plumb a pressure plenum fed by a “tank farm” which is more convenient, as it can be refilled by a truck located at ground level. Either way, consider how the system will be used and plan a strategy for replenishing lifting gas. Have an initial planning discussion with your helium gas vendor.



DANGER: Do not use hydrogen as a lifting gas, the system was not designed to be explosion proof. Historically, hydrogen gas has often been used for radiosonde balloons, as it can be generated on site economically. This economic incentive often lures people into using hydrogen instead of helium, in order to save money on upper air soundings. However, hydrogen is combustible and the ARL *is not designed to use a flammable lifting gas*. The semi-enclosed environment of the system can trap gas, and in the dry winter months friction from the balloon exiting can create static electricity discharges that will ignite it. *Never, under any circumstances, connect a hydrogen gas source to the system as it may result in fire or explosion!* Yankee Environmental Systems, Inc. its employees or shareholders bear no legal liability for misuse of this product, whether intentional or otherwise. Play it safe, never use hydrogen gas for any reason.

The mobile Model ARL-9001 has mounting locations for several 130 lb. helium

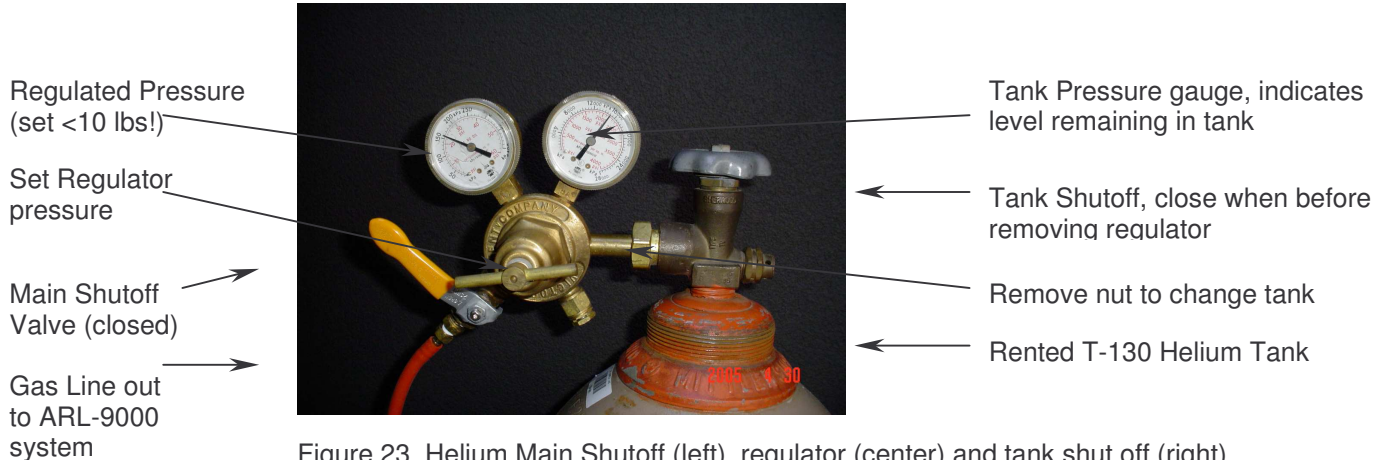

Figure 23. Helium Main Shutoff (left), regulator (center) and tank shut off (right).

tanks, enough for at least eight flights using 600g balloons. However, if sited atop building where it is physically inconvenient to replenish tanks, a licensed plumbing contractor with a gas license should install a rigid (iron/steel) gas line from the tank farm area to the system. This line must be professionally installed and each joint leak tested, following all local and national plumbing codes.

Caution: Please read High Pressure Gas Safety Guidelines on page 4-3.

Begin by connecting the supplied regulator valve to the top of the tank, which lowers pressure to <10 PSI. Exceeding 15 PSI can pop hoses off in the gas management unit.



DANGER: Loaded helium gas tanks have several thousand pounds per square inch (PSI) inside them. This mechanical pressure is extremely dangerous if unleashed. The tank can become a rocket if tipped over and the top valve breaks loose. In-building gas lines must be regulated down at the tanks to no more than 150 PSI between the tank farm and the system itself. A lower pressure regulator (provided with the system) can then drop the pressure at the ARL-9000, which your local plumber can install.

Helium can be an attractive nuisance, especially around young students. While helium is inflammable, it is colorless odorless can theoretically cause oxygen deprivation if consumed for a prolonged period. Helium is also expensive and if a leak develops you can lose your entire tank farm. It is therefore good practice to do an end-to-end system leak check just after installation and yearly thereafter to track down and fix leaks using a soap solution brushed onto joints to search for soap bubbles. Compressed air can be used the line is flushed afterwards with helium.

Always close the master valve at the tank, to prevent a slow leak from draining the tank. When changing tanks over, always close the tank valve.

If you want to track helium gas usage, you can install an exterior helium gas meter to track your helium gas consumption.

System Preliminary Testing

Once the antennas are connected and the system is plugged in to an AC power source, locate the Master Power Box near the equipment rack and pull the Master Power Switch (red pull knob on the left), and the blue light above should now be on.

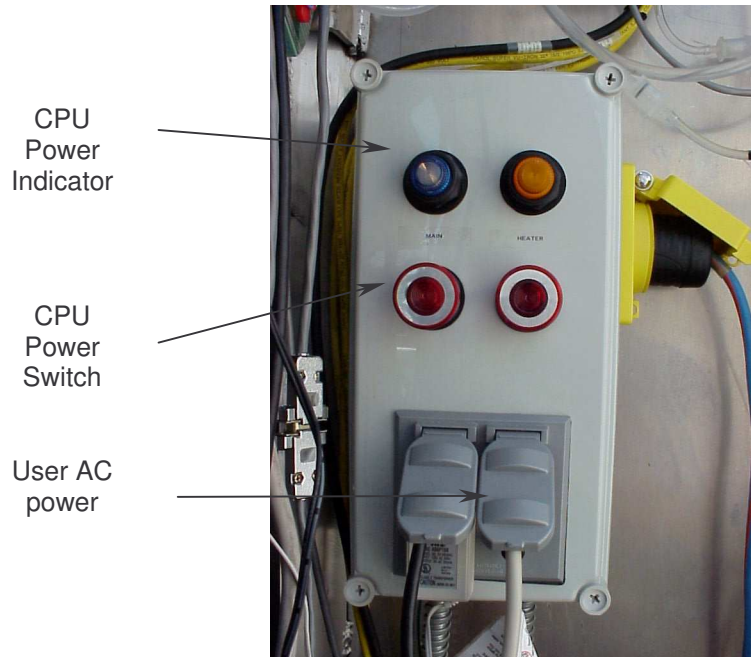

Figure 24. Master Power Box located on inside wall of system inflation area. Main AC input is yellow plug at right, four non-GFCI convenience outlets are provided.

Power-on the System

If not already turned on, power-up the METHUB and verify it has TCP/IP connectivity to your network by pointing your browser at the METHUB's TCP/IP address.

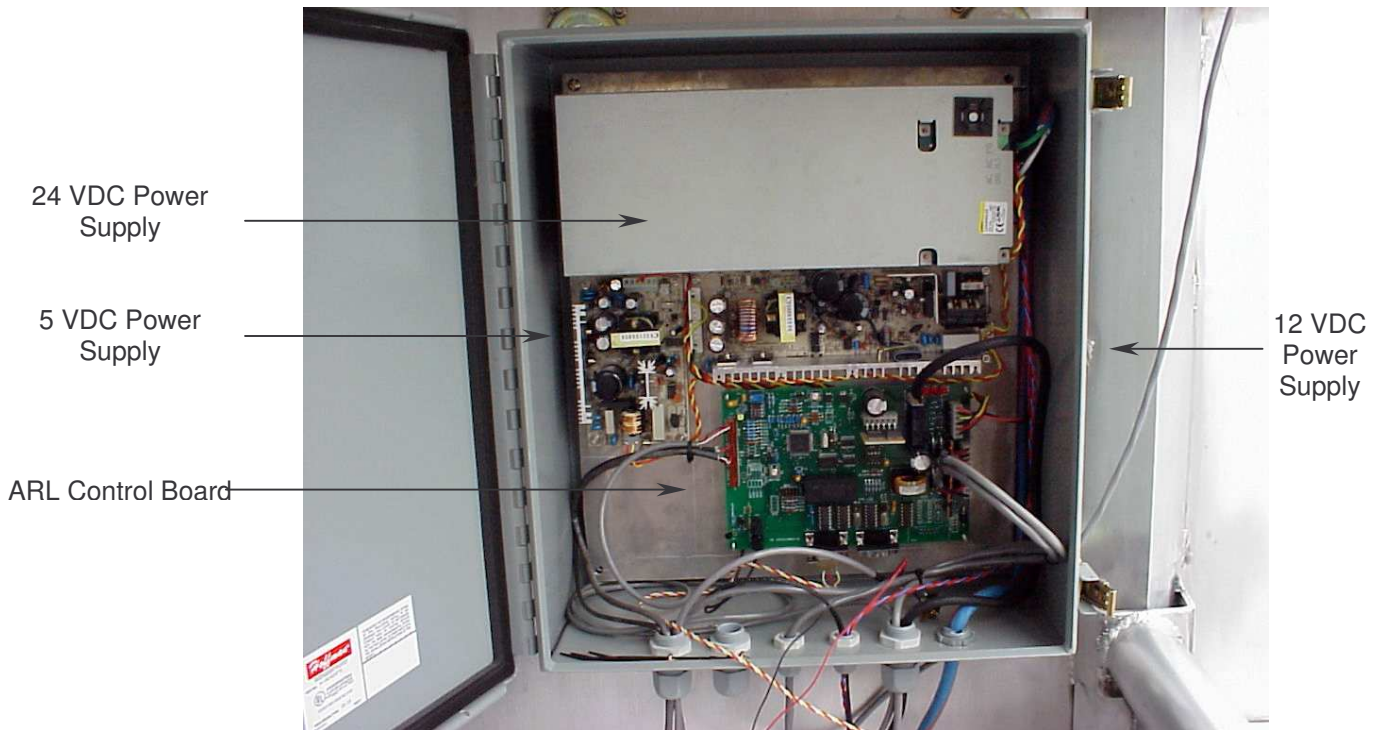

Figure 25. Main control board, located inside electronics enclosure.

Testing the CPU Hardware

Using Alex

If you just powered the METHUB on, wait until the systems boot up - this can take a minute or two. If you attach a VGA screen to the METHUB (not required), you will see a login screen. Switch on the METHUB and verify the power LED is on and that you see periodic disk drive and LAN activity. Using the controls on the left of Alex, activate the battery and setup a radiosonde on one of the shelves in the system to generate a test RF signal. Listen on the METHUB audio monitor speaker for the carrier.

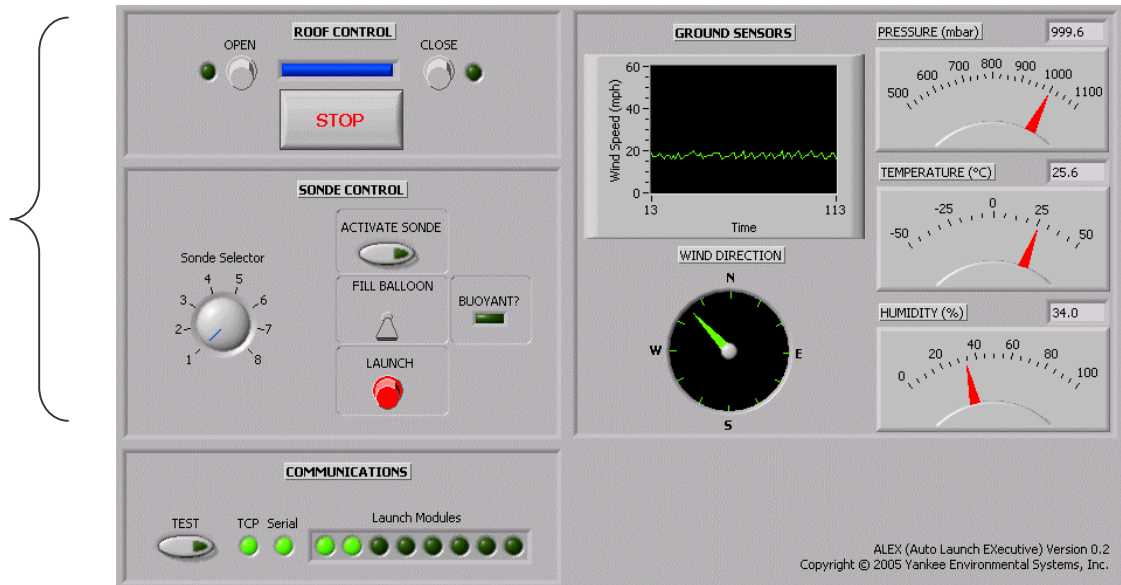

Figure 26. ALEX is used to exercise each control function.

Test the helium valves and tubing cutters

connected to the system regulator, and the gas valve at ≈ 10 PSI (on the left hand output gauge), lift the satellite assembly and insert the tubing through the helium tubing cutter and connect to the helium valve output nipple. Lower the satellite assembly back into the floor (Figure 28). Using Alex, click on Activate Sonde, then fill then Launch for each channel and verify proper operation.

Warning: Verify both shipping bolts are removed from both sides of the roof before beginning this test!

Test the roof



To test the roof operation, press the open button. This will activate the yellow flashing safety light and beeper and start moving the roof to the open position. For safety reasons, the roof moves slowly and takes about 2 minutes 15 seconds to open. To close the roof, click on **Close**. The roof should completely close in about 2 minutes 15 seconds.



Figure 27. Radiosonde on shelf (door is already open).

Test the battery arming fiber optic links

Make sure the radiosonde has its power activation fiber optic cable properly fed through the vertical support as shown in Figure 27.

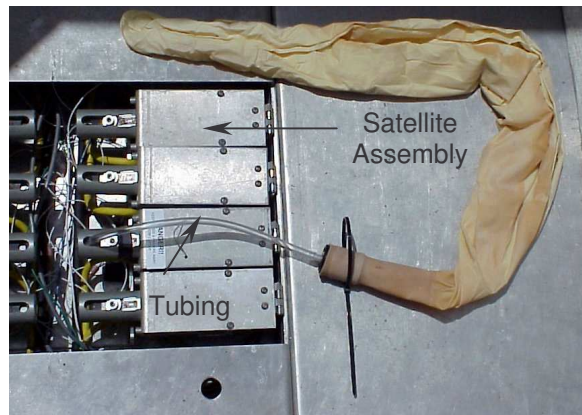

Figure 28. Cutter/valve assembly returned to the floor and ready for helium delivery test (no unwinder attached.)

Click on *activate sonde* to turn on the radiosonde and start RF transmission. Once transmitting, with the volume turned up, you should hear the RF signal carrier on the METHUB data receiver's audio monitor speaker.

Note: If you look in the end of the fiber for a few seconds you will observe light on the selected radiosonde. Remember to mark the test sonde for a new battery as this will deplete it and you do not want to use it a second time without swapping the battery.

CHAPTER 3

Launching Radiosondes

The system can be used fully automated, programmed to launch radiosondes at predetermined times without operator intervention, or you can launch one or more pre-loaded radiosondes on demand, we refer to this latter mode as *manual* operation.

Note: Once a balloon is removed from its packaging, its shelf life is finite. Before opening expendables, determine how soon you will be using them. Follow balloon manufacturer guidelines for optimum performance. For example, if you intend to launch all multiple radiosondes synoptically over a several day period, you can pre-load as many as you need. However, if you will only launch one radiosonde at a time, in order to keep the humidity sensor as uncontaminated as possible load one a at time

Getting Familiar with the Hardware

There are four major Line Replaceable Units (LRUs) in the system:

- Main Controller (CPU) *Electronics Module* (wall mounted)
- *Gas Management Module* (floor-mounted)
- *Roof Actuator Motor* (mounted outside)
- METHUB *Meteorological Data Receiver* (mounted indoors)

Now that the system hardware is installed, you can start loading expendables.

Radiosonde Preparation

You can pre-load from one to eight XDR-928 radiosondes in the system for automated launch. This section describes how to prepare the radiosondes.

Pre-load the Radiosonde

Note: The only difference between preparing for a single semi-automated release versus multiple releases are the stations that gets populated. The battery must be armed on each radiosonde before it can be automatically activated. Carefully handle each XDR-928 during the loading process.

Open the flap on the side of the radiosonde to expose the sensor boom.

Arming the Battery



Sensor
Boom

Figure 29. XDR-928 Radiosonde.

Avoid touching the sensors with bare fingers! Place the jumper over the two pins marked “ARM”. The LED should not be on. Next, carefully place the radiosonde on the fiber optic probe and slip it into the tube on the appropriate shelf. Aim it such that the sensor boom is directly over the aspiration duct. Avoid bending the plastic optical fiber too tightly. Proceed *Balloon Preparation*.

Balloon Preparation

This section describes how to prepare a single sounding balloon.

Note: The chief difference between the ARL and manual launching a radiosonde is the gas check valve, which stops gas flow after release.

Install the Check Valve

The components required include the balloon, check valve, and rubber tubing.



Figure 30. Expendable balloon components include the sounding balloon, gas check valve, and ≈ 12 " (25 cm) piece of $\frac{1}{4}$ " (6.4 mm) ID PVC tubing.

Attach the helium delivery tubing to the one-way gas check valve. *Be sure to attach the tubing to the valve end protruding from the outside of the black valve holder, not the recessed side.* Avoid placing too much force on the valve.

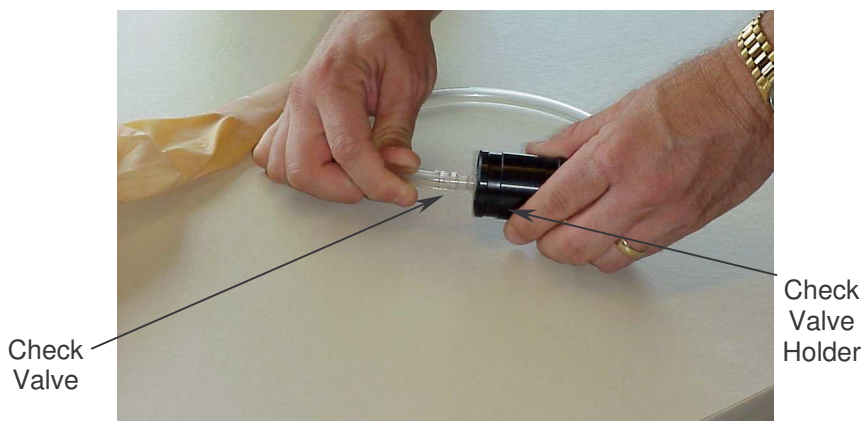

Figure 31. Connecting the helium delivery tubing to the check valve.

Note: The one way check valve has a polarized orientation—if you install the check valve backwards the balloon will fail to inflate properly.



Figure 32. Inserting the check valve holder into the balloon neck.

Carefully slip the check valve holder into the balloon neck. The end of the balloon neck should be about even with the bottom of the valve holder as shown in Figure 33. Avoid pressing on the check valve neck while slipping the balloon on. The assembly is now ready to be placed in the inflation area and connected to the *Gas Management Module* valve nipple, after threading through the cutter.

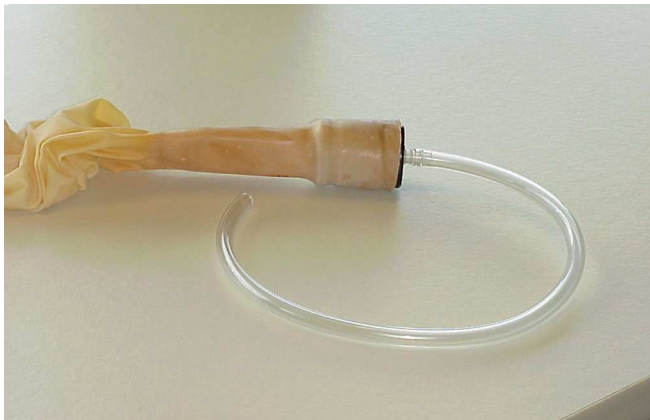

Figure 33. Completed check valve assembly.

Gently layout the balloon on the inflation area floor area with a cable tie.

**Pre-loading
Balloons**

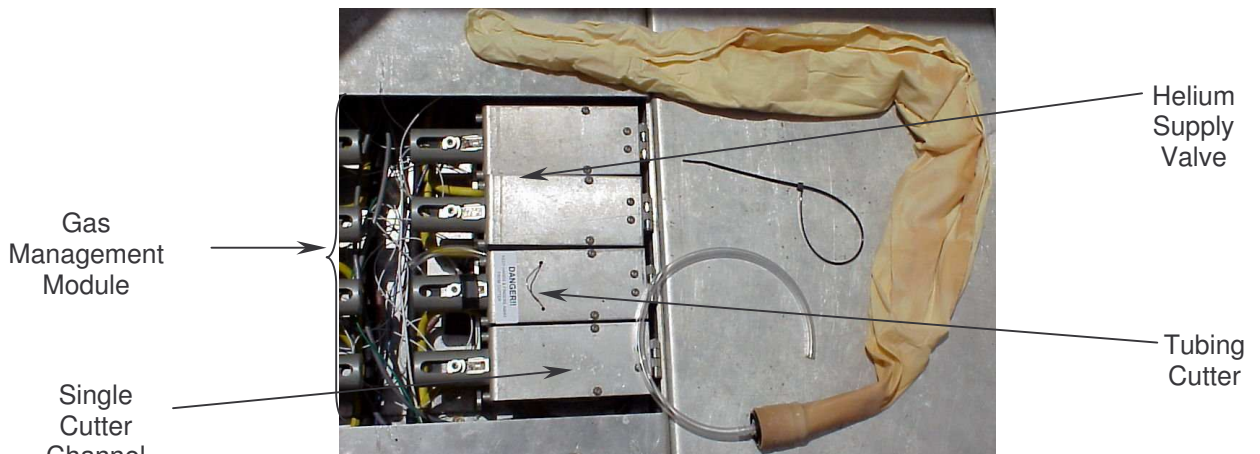

Figure 34. Balloon with completed check valve assembly and cable tie.

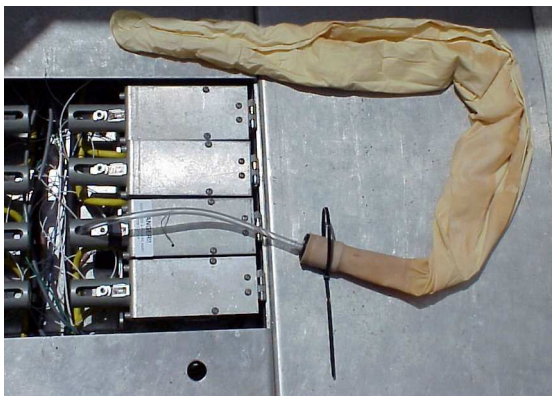

Figure 35. Cutter placed back in launch position.

Loosely wrap a cable tie around the balloon neck. Lift up the cutter (no more than one inch) and feed the helium tubing through the cutter and then connect it to the helium supply valve under the cutter. Carefully lower the cutter module back down into Gas Management Module so it is level with the floor. Now place the unwinder through the cable tie and carefully tighten the cable tie around the balloon neck until the unwinder is snug against the balloon.

Verify that the tether on the unwinder is not located between the balloon and unwinder, as it needs to be able to unwind freely in the first few seconds into



Figure 36. Unwinder is placed through cable tie at balloon neck.

balloon ascent. Cut off the excess cable tie beyond the grip point to reduce the weight. The balloon is now ready for inflation and launch.



Figure 37. Completed balloon assembly with cable tie trimmed, ready for inflation.

Note: If you will be loading more than one balloon, be very careful not to step on them. Even if they do not tear, they will tend to burst prematurely.

As many as seven more balloons and radiosondes can be loaded in similar fashion. Lay each balloon out in a circular extended pattern on the floor similar to a flower. Use extreme care not to step on any balloons as you work. Work methodically to verify the correct radiosonde on the upper shelf is tethered to the balloon below, use care not to mix them up, as you run the risk of accidentally releasing a radiosonde that has not been activated.

Caution: Avoid pulling the gas module out of the gas management module more than 1" (as shown in Figure 38). Doing so will damage the flexible hinge and render the inflation buoyancy sensor inaccurate.



Figure 38. Tubing fed through cutter and attached to helium supply valve. Do not lift the satellite module up as far as shown or damage to the hinge will result!

Conducting Radiosonde Launches

Verify the system is powered on. Follow procedures in the sections *System Preliminary Testing* and Testing the CPU Hardware.

Important: Completely test the system before attempting a launch.

Next, prepare the balloon using the procedures in *Balloon Preparation*.

Prepare a radiosonde

Note: Connect the radiosonde unwinder to the balloon you prepared and place the radiosonde on the appropriate sonde station in the launch bay. Do not forget to connect the unwinder by following the procedure in the section *Balloon Preparation*.

Inflating the Balloon

With a radiosonde functioning within normal parameters, turn the rotary *Sonde selector* to the balloon that you previously prepared and toggle *Fill Balloon* on.

Sonde Controls

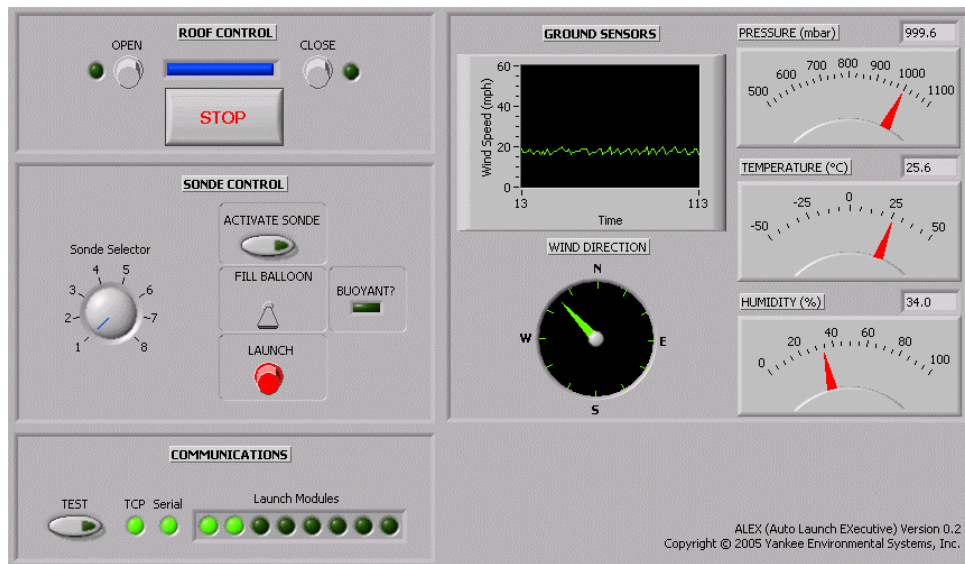

Figure 39. ALEX Software. Sonde activate/fill/launch controls are at right; real time ground truth PTU+Wind data is at right.

Warning: Make sure you have removed the shipping bolts from both sides of the roof before opening the roof!

Watch the balloon fill on the internal camera. When the *Buoyant* indicator turns on in a few minutes on, click on “Launch”. Once the balloon is safely away, you can click on close the roof.

No user action is necessary at this point. Once the balloon is released, the ground station software will automatically receives radiosonde data and archives data to YESDAQ, whereupon you can use the web DVE to access it.

A flight with a brand new 300g balloon will typically last from 50 to 90 minutes, depending on weather conditions. When the balloon bursts and/or RF telemetry is lost, the flight terminates and all data are archived in YESDAQ.



Post flight, you can look at Stored Data from your web browser using the YESDAQ Data Visualization Engine (DVE). Start the browser (IE) and enter the URL for the local ARL (e.g. <http://arl-core>).

Note: We recommend you use Internet Explorer (IE) version 5.5 or later. Other browsers may exhibit display problems. If you have trouble with refreshes, try update the Sun Java Virtual machine.

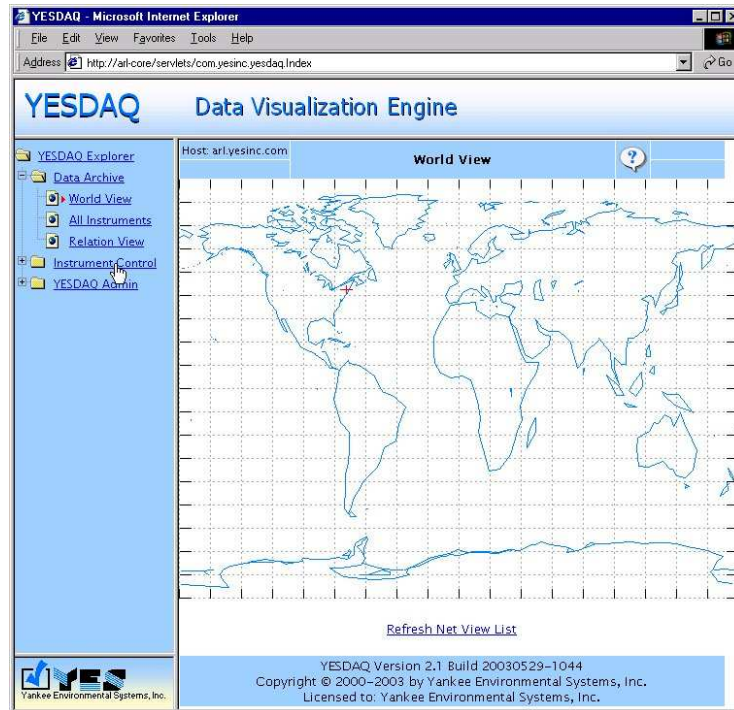

Figure 40. YESDAQ DVE World View; click on your location to drill down to data.

Database Access via ODBC, JDBC, DBI

In addition to the DVE you can access YESDAQ data directly via several open connectivity database drivers. Open Database Connectivity (ODBC) and Java Database Connectivity (JDBC) connections support live links to third party MS-Windows applications such as *MS-Excel*, *Matlab*, *S-Plus*, *Crystal Reports*, as well as your own Java applications.

Before database access is possible, you must create database user accounts. This is described in detail in section Managing YESDAQ Database Accounts on page 3-10 using *YESDAQ Service Manager*.

Managing YESDAQ Database Accounts

All upper air data is stored in YESDAQ, a relational database. There are several levels of password protection. If you're using the DVE to provide users read only access via web browsers, only system administrators need access to the high-level system password. If you use ODBC or JDBC to let users link to other analysis or database tools, the need for a password control policy becomes an important issue. As with any host system remotely accessible by users via TCP/IP, you should exercise strict control over passwords.

Caution: For security reasons you should change the default admin level password and then *write it down*. Also, never assign high level access to general users. Instead, create *user* level accounts for them. Do not lose the admin level password as it is not possible to retrieve with a reinstall of YESDAQ.

From the *YESDAQ Database Service* tab, you can choose to add, modify, delete, and review definitions of database accounts. To work with database account definitions, click the *Accounts* button on the *YESDAQ Database Service* tab.

If you are already logged into YESDAQ, the *User/Agent Accounts* window appears, as shown in the following figure. If you are not logged in, you must login first. The parameters for *User/Agent* accounts include:

- **Host:** List the Domain Name Service (DNS) host name or TCP/IP address of the YESDAQ host to which each user is assigned. The default is **localhost**. You can also use the wildcard character (%) to indicate any host (for example, **%mycompany.com**, refers to any host at **mycompany.com**).
- **User:** List the user name for each account.



Figure 41 Viewing User/Agent Accounts

- **Privilege:** Describe the level of privilege assigned to each user account.

Action buttons include:

- **New:** Add a new user account (see Creating New User Accounts below).

- **Remove:** Permanently removes a selected user account. Note the special *admin* user account cannot be removed.
- **Password:** Add or change a password for a selected user account. Passwords are case sensitive.

The following two accounts are created by default at installation, write down your passwords:

ACCOUNT	PASSWORD	DESCRIPTION
admin		Administrator access; has all administrative privileges.
web_agent		Allows application/web server to access the database.

Creating New User Accounts

When a user requests ODBC or JDBC access to the YESDAQ you should create a user level account for them. To create a new user account:

- 1 In the User/Agent Accounts window, click *New*.

The *New Account* window appears.



Figure 42 New User Account

- 2 Enter the following information:
 - **Host:** Identify the host system for the account. You can enter a DNS host name, a TCP/IP address, or use the wildcard character (%) to indicate any host name or TCP/IP address. The default value for the host name is **localhost**, which is typically the same workstation YESDAQ is installed on.
 - **User:** The assigned user name. Note that names are case sensitive.
 - **Privilege:** The privilege level assigned to the account:
 - *Administrator* privilege allows the account to create, remove, or change user definitions and to change the contents of the YESDAQ database (for example, by inserting or deleting data or by changing the structure of the database tables).
 - *Agent* privilege allows the account access to the YESDAQ database and make changes to its contents. It is advisable only to permit experienced programmers access to the contents of YESDAQ tables.

- *User* privilege allows the account to access the YESDAQ database and retrieve data for viewing or reporting only.

3 When you finish entering the information, click *OK*.

A *Create/Change Password* confirmation window appears, asking you to create and confirm a password for the new account.



Figure 43 Password Dialog

4 Enter a password and reconfirm it, then click *OK*.

You return to the *New Account* window, where you can make further account changes.

Changing User Accounts

To make a change to an existing user account, you must first remove the existing account and then re-add a new user account with new information.

Note: There is no stored user data to be destroyed other than username and password. Data in the database is unaffected by adding and removing users.

Removing User Accounts

To *permanently remove* an existing user account:

- 1 In the *User/Agent Accounts* window, select the account you want to delete.
- 2 Click on *Remove*. A confirmation window appears. Click *Yes* to delete the account.

Warning: Removing users is a permanent operation, there is no “undo” function.

Using Open Database Connectivity Drivers

Once database accounts are established, you can establish an Open Database Connectivity (ODBC) data reference between your client application and YESDAQ. Before you can access YESDAQ data from a remote system (where your application is running), you must install the MySQL ODBC drivers on that host. ODBC drivers for the MS-Windows platform are provided on the YESDAQ CD-ROM that was supplied with the METHUB. To install the MySQL ODBC driver on your PC follow these steps:

- 1 Insert the YESDAQ CD-ROM into the CD-ROM drive and wait for the Welcome screen.
- 2 Click on the *Install YESDAQ ODBC Client* link, which installs the MySQL ODBC driver.
- 3 In order to provide access to ODBC for your MS-Windows application you must provide a Data Source Name (DSN) in your ODBC control panel applet. The YESDAQ installation and the YESDAQ ODBC Client installation each create a default DSN named *YESDAQ* in the ODBC control panel applet for you to use.
- 4 Configuring ODBC/JDBC drivers requires a solid understanding of how your third party application interact with YESDAQ database tables. In particular, the data table definitions and specific variables. You can explore the YESDAQ table definitions and structure via the YESDAQ Data Visualization Engine.

ODBC data sources can be defined as *User DSN* or *System DSN*. The User DSN source is accessible to users that are logged into the workstation, while the System DSN is accessible to the background NT services. YESDAQ itself does not use the DSNs defined in the control panel, since it creates one automatically.

The configuration for the YESDAQ MySQL data source is as follows:

- **Windows DSN Name:** The name of the Data Source.
- **MySQL host:** The DNS host name or TCP/IP address of the MySQL database host.
- **MySQL database:** The name of the database, for YESDAQ this is *YESDAQ*.
- **User:** The user account you created earlier.
- **Password:** The password assigned to the above user account.
- **Port:** The port number assigned to the database server, the default is 3306.

At this point, you can use your application data access interface to access the YESDAQ data. Refer to your third party application's *User Guide* or *Programmer Guide* to learn more about using ODBC connections.

Note: Due to the extremely wide variety of software applications on the market, YES cannot provide free technical support on setting up your application to use ODBC connections.

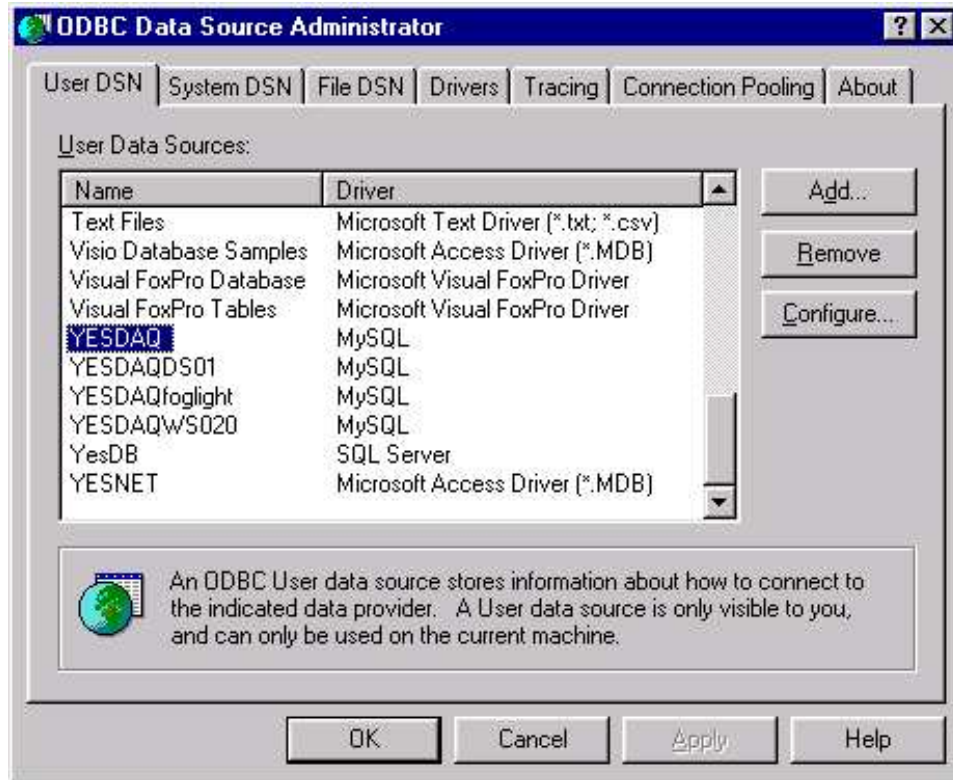

Figure 44 ODBC Data Source Administrator

Using ODBC drivers with the Macintosh OS

While Microsoft developed ODBC, however, it is supported by other platforms such as the Apple Macintosh® and several other popular databases. Commercial third party ODBC drivers for MySQL are available from www.thecompany.com and www.metrotechnologies.com.

Using Java Database Connectivity drivers

Very similar in spirit to ODBC, JDBC access is provided via the Java programming interface and is intended for advanced Java developers. The JDBC driver is a native driver, which does not require external libraries. Note that YESDAQ itself accesses the MySQL database via JDBC.

In the YESDAQ installation directory, under the directory *javalib* is the jar file containing the MySQL JDBC interface. This jar file is called *mysql-2.0.8.jar* but may be slightly different depending on the exact release. You will need to include this library in your Java application development environment, and then use Java's *java.sql* package to access data.

The latest up-to-date JDBC drivers are available via www.mysql.com

Note: Due to the extremely wide variety of software applications on the market, YES cannot provide free technical support on setting up your application to use JDBC connections.

Using the Perl Database Interface

In addition to ODBC and JDBC, you can use the Perl language to access YESDAQ data. Perl uses the common DBI interface to access databases. It is required in addition to the database driver-specific module.

To get the Perl driver, visit the download page on www.mysql.com to find the contributed MySQL Perl API drivers.

Support for other Programming Environments

Several other programming environments support working with MySQL data, such as open source Python and Ruby tools and Microsoft's .NET technology. Please visit www.mysql.com for more information on using other environments.

Caution: If you change the default YESDAQ database administrative password and then lose it, you must re-install it and will lose all of your data. There is no way to recover data so *record the password in a safe place!*

CHAPTER 4

Maintenance and Troubleshooting

In any system with moving parts inevitably, some components will fail. Typically problems the tubing line cutters need blades replaced or adjusted, or the roof door motor actuator needs lubrication. Sometimes, TCP/IP networking problems develop (contact your LAN administrator for help).

There are five major Field/Line-Replaceable Units (LRUs) in the ARL-9000/9001 system:

- Main CPU Electronics Module, wall mounted inside the inflation area
- Gas Management Module, floor-mounted in the inflation area
- Roof Door Actuator Motor, mounted outside the inflation area
- PTU-2000 Meteorological Sensor, mounted outside the inflation area
- METHUB Meteorological Data Receiver, mounted indoors

External issues such as AC or LAN problems or gas delivery are your responsibility. However, if the tubing cutters or roof door motor actuator develops a problem, there are certain items you can service yourself, or if not, you can return those LRUs to YES for factory service.

Note: When troubleshooting any system it is always best to first try to isolate various sections and then test each one separately. Ask yourself: Did the system ever work properly? If no, it is an installation issue. If the system used to work, ask what changed about the system or its operation since that time? That change might be the root cause of the problem.

The *CPU Electronics Module* LRU contains the system +5, +12 and +24 Vdc power supplies. It communicates to the floor-mounted *Gas Management Module* LRU via a single fiber optic cable, to the *Roof Door Actuator*, aspiration fans and anemometer/wind vane via cables, and to the YES Model METHUB and PTU-2000 meteorological sensor via RS-232 serial cables.

The floor-mounted Gas Management Module LRU is modular and has several moving components in each of its eight channels, including tubing cutter servos and a lift sensor proximity switch. The Gas Management Module activates armed YES Model XDR-928 radiosondes placed on shelves in the four corners of the inflation chamber via fiber optic cables. Each shelf holds two radiosondes.

Routine Maintenance

Routine maintenance, other than replacing expendables such as helium lifting gas tanks, is minimal. Periodically, you will want to change the razor blades used in the gas management module. These are [X-acto](#) brand blades and can be ordered from [McMaster-Carr](#).

High Pressure Gas Safety Guidelines

While the system was designed using best practices, moving heavy steel high-pressure gas tanks requires extreme care. Use a tank dolly to move gas tanks and always keep them tied to a wall safety stand with the thread on metal top in place when not in use. Follow the guidelines in this section:

Pressure Hazards

Even with an inert gas such as helium, all compressed gases are hazardous because of the high pressures inside the cylinders. Even at a relatively low pressure, gas can flow rapidly from an open or leaking cylinder. Damaged cylinders can become rockets or pinwheels that can cause severe injury and damage. An unsecured, uncapped cylinder is a major accident waiting to happen. If such a cylinder is knocked over causing the cylinder valve to break, the compressed gas will escape at rocket velocity. A poorly controlled release of a compressed gas in systems can also cause vessels to burst or create leaks in equipment or hoses.

Identification, Signs, and Labels

Never use a cylinder whose contents cannot be positively identified. All cylinders must bear an identification tag stating the name of the gas or mixture and a tag stating one of three conditions: full, in-service, or empty.



If the labeling or the attached tag on a cylinder becomes unreadable or is missing, the cylinder should be marked “contents unknown” and returned to the supplier. Commercially available three-part tag systems can also be used to specify whether the cylinder is full, in use, or empty. Click [here](#) for downloadable warning labels for some commonly used compressed gases.

Never rely on the color of the cylinder for content identification. Color-coding is not reliable because it can vary with the supplier and because colors can appear different under artificial lights and some people are color blind. Don’t base your identification of a gas in a cylinder on the cap label because caps can be easily interchanged.

All gas lines leading from a compressed gas supply should be clearly labeled with the identity of the gas, the laboratory or area served, and pertinent emergency telephone numbers. Post signs in areas where compressed gases are stored, identifying the substances and appropriate precautions such as “Flammable Gas – No Smoking – No Open Flames.”

Never use a cylinder whose contents cannot be positively identified. Do not rely on color coding for gas identification. All cylinders must bear an identification tag stating the name of the gas or mixture and illustrating one of three conditions: full, in-service, or empty. Do not remove or deface any marks or tags attached to the cylinder by the supplier.

All compressed gas cylinders must be clearly labeled with the correct name of their chemical contents. Handwritten labels are acceptable as long as they are easily readable. Do not use chemical formulas or structural formulas to identify cylinder contents.

Obtaining and Purchasing Cylinders

Always try to purchase cylinders from companies that have a cylinder return policy. The cost of disposal for gas cylinders is dependent upon the material, but even non-hazardous cylinders can be expensive to dispose of.

Avoid purchasing a larger cylinder size than is necessary. It also increases personal risk in the event of an accidental release. Larger cylinders can be more difficult to store in areas where ventilation is required and of course, they take up more room.

Inspect all incoming cylinders before storing to ensure that they are undamaged and properly labeled. Do not accept delivery of defective cylinders. Be sure that they are not giving off odors, visible fumes, or hissing sounds. Also check that the cylinder identification labels are intact and that they match other identifying markings on the cylinder.

Handling and Use Securing the Cylinder

Consider cylinders of compressed gases as high-energy sources. Gas cylinders must be secured at all times to prevent tipping. Cylinders may be attached to a bench top, individually to the wall, placed in a holding cage, or have a non-tip base attached. Chains or sturdy straps are usually used to secure them. Set up the cylinder so that its valve is easily accessible at all times. For cylinders equipped with a stem valve, the valve spindle key should remain on the stem when the cylinder is in service.

Cylinder Valves, Regulators, or Other Fittings



Never tamper with any part of a cylinder valve. The threads on cylinder valves, regulators, and other fittings should be inspected prior to use to ensure compatibility. To prevent the mixing of incompatible gases, the [Compressed Gas Association \(CGA\)](#) has devised standard cylinder-valve outlet connections. Since outlet threads used vary in diameter and placement, the use of CGA-standard combinations of valves and fittings is recommended. Use only cylinders with matched connectors and proper CGA regulators. Never install cylinder adapters on a regulator. Do not attempt to repair cylinders or cylinder valves or force open cylinder valves. Contact the supplier for advice.

Caution: Cylinders stored in cold areas may have frozen valves. Use only warm water to thaw the valve or allow it to thaw at room temperature. Never directly apply heat to a gas cylinder.

Opening and Closing Cylinders

Open cylinders slowly with the valve pointing away from you and open it all the way. Always have the valve pointed away from you when opening or closing valves. If you cannot open it by hand, the valve should be repaired. Avoid leaving the valve open when the cylinder is not in use, even when empty. Air and moisture may diffuse through an open valve causing contamination and corrosion within the cylinder. Only tools provided by the cylinder supplier should be used to open or close cylinder valves. Never use pliers!

Close cylinder valves when not in use, and then bleed pressure from the regulator. Store with cylinder caps in place. Do not use a wrench to open or close a hand wheel-type top cylinder valve.

Testing for Leaks

Leak test all connections to a cylinder because any gas, regardless of its health hazard, may cause asphyxiation by displacing oxygen. Piping systems should also be inspected for leaks on a regular basis. Leak detection procedures should be implemented prior to using any compressed gas system.

Testing Cylinders

Cylinders must be tested every ten years. There should be a last test date on the top of the cylinder. Notify your supervisor and the supplier if outdated cylinders are identified.

Things to Avoid With High Pressure Gas Cylinders

- Do not attempt to use a cylinder without a regulator or some other pressure-reducing device in place.
- Never strike an electric arc on a gas cylinder and keep it clear of sparks, flames and electrical circuits. Arc burns can make the metal brittle and weaken the cylinder.
- Never tamper with cylinders in any way. Do not repaint them, change markings or identification, or interfere with valve threads or safety devices.
- Apart from the fact that it is illegal, it can be dangerous for non-specialists to refill cylinders or to change their contents. Explosions, cylinder contamination, or corrosion can result.
- Plastic fittings or tubing must not be used for any portion of a high-pressure system.
- Do not use Teflon tape on cylinder connections or tube-fitting connections because it could interfere with the fittings and cause leaks or clogging.
- Copper fittings or tubing, including bronze or brass ones containing more than 65% copper, must not be used on acetylene tanks – explosion may result. Acetylene also forms explosive compounds in contact with silver and mercury or their alloys.
- Ammonia attacks brass and can react with mercury to form an explosive compound. Do not use mercury pressure gauges in ammonia systems!
- Do not hang clothes or equipment over a compressed gas cylinder. Clothing can become saturated with a hazardous gas. If the gas is oxygen, clothing can catch fire and burn easily.
- Never interchange regulators and hose lines specifically for one kind of gas for another. Explosions can occur if flammable gases or organic materials come in contact with oxidizers (oxygen) under pressure.
- Never tamper with or attempt to alter cylinders, valves, or any safety relief device. Return cylinders to the supplier for all repairs.
- The MSDS for the particular compressed gas should recommend appropriate materials. If it does not, contact the gas supplier for specific information. Know and be familiar with the right PPE for use in emergencies as well as during normal operation. It cannot provide protection if it is not worn.
- Ordinary prescription glasses do not provide adequate protection. Wear safety glasses with side shields when handling compressed gas cylinders, especially those containing acutely toxic gases. Safety glasses with side shields do not provide sufficient protection from splashes. If the potential for splashing is present, a full-face shield should be used. OSHA requires that safety glasses always be worn underneath a full-face shield. Wear safety glasses and a face shield when disconnecting regulators and lines.

Solving Power Problems

Communications or lack of power is often the root of problems. Proper power flow to each LRU in the system is mandatory—if a subsystems fails due to a blown fuse or power supply failure, it will prevent operation of the system. There are several steps to take when debugging power problems. Fuses are in several locations.

- 1 Start by determining that there is AC power actually being delivered to the system. Check the system's main power switch on the rear wall AC junction box, and equipment AC switches (as items may have inadvertently shut off by the operator). Is the indicator light on? Does the heater operate?

Note: Ground fault interruption (GFCI) circuit breakers can trip easily, shutting down the system, and ground currents from nearby lighting strikes can trip GFCIs. The aluminum system chassis is fully grounded, so only if local code requires it do you really need to need to use a GFCI.

- 2 Next, turn off the AC power and check individual fuses on equipment. The PTU-2000 has a fuse inside its blower housing, and there are fuses inside the electronics module on each of the DC supply outputs. Use a DVM to measure the output of each supply
- 3 Look for loose wires at connectors, or for fiber optic cables that may have slipped out of their mechanical retention collars.

If you need more help debugging power issues, contact YES via the methods described in the following section.

Specialized Service

Other than the DC fuses in the ARL CPU Electronics Enclosure, the Gas Management Module's tubing cutter blades and the inflation area's four DC aspiration fans, there are few user-serviceable parts in the system. We recommend that you return Line Replaceable Units (LRU) assemblies needing repairs to YES for service. However, if you have some technical expertise, you often repair or adjust these items yourself:

- Upgrading the firmware in the CPU LRU
- Replacing the roof motor actuator LRU
- Replacing the gas management module LRU

This section describes how to make these repairs and return a system or assemblies to YES.

Returning Line Replaceable Units for Factory Service

If you're shipping LRUs back to YES for repair or recalibration, be sure to follow the guidelines in on page 4-9.

- Contact YES for a *Return Merchandise Authorization* (RMA) number by any of the methods in the section *In this Manual* located just after the table of contents. A detailed RMA procedure is at www.yesinc.com/support.html
- Wrap the system in bubble plastic and place it in a wooden crate or double weight reinforced cardboard box.
- Insure the instrument for its full replacement cost and ship it freight and insurance prepaid in accordance with the RMA Instructions provided at www.yesinc.com/support/html

Note: YES does not accept COD packages. For international shipments, ship door-to-door, not to a "US port of entry".

Upgrading the CPU system firmware

To upgrade the system firmware:

- 1 Disconnect AC power to the system.
- 2 Place an anti-static wrist-grounding strap on your arm.
- 3 Remove the CPU electronics enclosure cover mounted on the back wall. Note that the cover has a gasket and the integrity of the gasket must be maintained to prevent moisture infiltration.
- 4 Carefully slide out the side cover on the internal electronics CPU to expose the firmware module.
- 5 Carefully note the position of the firmware module and swap it with the new firmware module.

- 6 Place the old firmware module the anti-static bag that the new module was shipped in. *Return this module to the factory to avoid a service charge.*
- 7 Inspect and verify the firmware module is fully seated in its socket.
- 8 Replace the enclosure door carefully.

Warning: The firmware module is static sensitive, please use caution in handling it and be sure to ground yourself when moving it between the anti-static bag and the system. Return the old module to Yankee Environmental Systems to avoid a surcharge. If you have any questions please contact Tech Support via any of the methods described in the *In this manual* section.

Replacing the Roof Motor LRU

Warning: The system roof door is quite heavy, be careful when removing the motor actuator LRU as it can fall unless you secure it with the roof bolts.

To replace a faulty Roof Door Motor actuator LRU:

- 1 Disconnect AC power to the system.
- 2 Note the position and bolts anchoring ends of the roof motor actuator LRU.
- 3 Install the two roof bolts into the roof door, such that it cannot fall on you when you remove the motor actuator LRU holding it place.
- 4 Remove the access door on the lower housing and note wire colors.
- 5 Remove the cable from the motor actuator LRU's internal enclosure
- 6 Noting the position of hardware, carefully unbolt the top end of the motor actuator LRU and set it down.
- 7 Unbolt the lower end of the motor actuator LRU and remove it.
- 8 Bolt in the lower end of the replacement motor actuator LRU in the proper orientation, then bolt the top end to the roof door.
- 9 Slip in the new LRU up and secure it in place.
- 10 Reconnect the cables in the correct locations inside the motor enclosure.
- 11 Now replace the enclosure door and seal it carefully by turning each screw only a few turns at a time (similar to an automotive tire lug nut rotation). As you tighten each screw, checking that the gasket is properly seated.
- 12 Check the two bolts are secure but not binding, and that the roof can operate.

Warning: The enclosure must remain completely dry inside at all times. When servicing use extreme care to seat the gasket properly.

Packing for Shipment

When packing Line Replaceable Units (LRUs) choose a box with adequate strength to handle the weight and any sharp edges. Consider that sharp edges can easily penetrate thin cardboard. You can also build a fully enclosed custom wooden crate.

Caution: Do not forget to insure your shipment. To avoid mechanical damage from vibration, never ship the system strapped to an open pallet and fully assembled. It should be shipped broken down.

Obtain and RMA Number first

If you are returning the system for service, do not return systems to YES without first obtaining a valid Return merchandise Authorization (RMA) number by following the RMA instructions listed at www.yesinc.com under *support*. Shipments arriving without freight prepaid (e.g. C.O.D.) will be refused, and those without valid a RMA number will experience a significant service delay.

We recommend that you insure your shipment using the carrier's own freight insurance. Freight carriers tend to take better care of items they are insuring themselves, and items ship without carrier insurance generally default to a few dollars-per-pound. More importantly, freight carriers will expect that you packed the item securely and intended it to take abusive treatment. Government users should be wary of shipping without insurance; the US government is self-insured, but freight companies often treat items shipped without insurance as though they are worthless.

Important Product Safety and Disclaimer Information

Important: READ THIS PAGE BEFORE USING THE SYSTEM! Also read the section High Pressure Gas Safety Guidelines on page 4-3.

Be careful!

Because the system has moving parts and uses tanks with gas stored under pressure, there is always the potential for injury. Pay attention to what is going on if you are in or near the system and it is operating, as parts can move at anytime under remote control. Keep hands and feed clear of the door while operating.

Never insert anything but PVC tubing in the tubing cutters. The system should be setup such that it is out of reach of the general public. For example, install it inside a secure fence line such that children and unauthorized personnel are denied physical access to it *at all times*. It is your responsibility to install and use the system with appropriate caution.

Lethal voltages present inside

There are lethal voltages inside the system electronics enclosures, therefore no work should be performed on junction boxes it while connected to line power - always disconnect AC line power by removing the yellow system plug on the side of the switchbox, before servicing the system. Only operators familiar with the detailed operation of the system should be allowed to maintain it, and all servicing is to be performed only by qualified, technically trained personnel.

Danger: Use extreme care when working on the system where the ground is wet, you can be killed! Always disconnect AC power first before opening the enclosure or touching the sensor head.

Advisory use only

The physics of meteorological measurements depend on complex thermodynamic behavior of the local atmosphere and is impossible to control. Further, due to the complex random and varied nature of wind and weather, this equipment is not designed or intended for hazardous or otherwise life-critical applications. Yankee Environmental Systems, Inc. (YES) provides this equipment *as-is* and makes *no warranty as to the suitability of purpose of the product or the data it produces*. All data provided by the system are for “advisory” use only. While best practices have been employed in the design and manufacture of the system, malfunctions can and will occur, requiring periodic user-maintenance and intervention.

Disclaimer

You agree to use the product and the data it provides *at your own risk*. YES, its agents, distributors, assigns, shareholders or employees are not responsible for any damages whatsoever, resulting from either proper or improper use of this product, or application of data it provides. Further, YES, its agents, distributors, shareholders or employees are not responsible for any injury or injuries that may result from improper installation, malfunction, system design elements, improper or normal operation, or as a result of real or perceived negligence on the part of anyone. By using the instrument, *you agree to these terms herein included* in this User Manual as provided with the system at time of purchase. If you have any questions about this policy or on using the equipment in your application, contact technical support before proceeding with installation or use via any of the methods listed in *In This Manual* located just after the *Table of Contents*.

Product Warranty

Warranty Terms

The YES standard product warranty applies only to defects in manufactured parts as described by its general product warranty located at www.yesinc.com.

Documentation Feedback

While we strive to provide the highest level of technical accuracy in this document, we welcome any comments you have on this user guide, both positive and negative. Please do not hesitate to contact us via any of the methods listed in the section *In this Manual* located just after *the Table of Contents*.

Also, be sure to check our corporate web site for the latest technical information—look in the *support* section, under the data sheets and in the *frequently asked questions* link. In addition to providing the latest development news, the YES web site www.yesinc.com offers downloadable software updates to licensed customers, and in some cases tutorials on topics too changeable or complex to be covered in a printed manual (such as videos demonstrating complicated service procedures). You can also submit feedback and questions directly to the YES engineering team via the on line support site.

