

AT32UC3A3

PA31	29	J1	1	JUMP_2_CONN
PA30	14	J2	1	JUMP_2_CONN
PA29	23	J3	1	JUMP_2_CONN
PA28	28	J4	1	JUMP_2_CONN
PA27	26	J5	1	JUMP_2_CONN
PA26	120	J6	1	JUMP_2_CONN
PA25	119	J7	1	JUMP_2_CONN
PA24/DAC-DATANO	112	J8	1	JUMP_2_CONN
PA23/DAC-DATAO	111	J9	1	JUMP_2_CONN
PA22	110	J10	1	JUMP_2_CONN
PA21	109	J11	1	JUMP_2_CONN
PA20	113	J12	1	JUMP_2_CONN
PA19	114	J13	1	JUMP_2_CONN
PA18	115	J14	1	JUMP_2_CONN
PA17	128	J16	1	JUMP_2_CONN
PA16	101	J17	1	JUMP_2_CONN
PA15	100	J18	1	JUMP_2_CONN
PA14	129	J19	1	JUMP_2_CONN
PA13	132	J20	1	JUMP_2_CONN
PA12	136	J21	1	JUMP_2_CONN
PA11	139	J22	1	JUMP_2_CONN
PA10	137	J23	1	JUMP_2_CONN
PA09	133	J24	1	JUMP_2_CONN
PA08	127	J25	1	JUMP_2_CONN
PA07	124	J26	1	JUMP_2_CONN
PA06	126	J27	1	JUMP_2_CONN
PA05	125	J28	1	JUMP_2_CONN
PA04	122	J29	1	JUMP_2_CONN
PA03	115	J30	1	JUMP_2_CONN
PA02	123	J31	1	JUMP_2_CONN
PA00	122	J32	1	JUMP_2_CONN

U1A

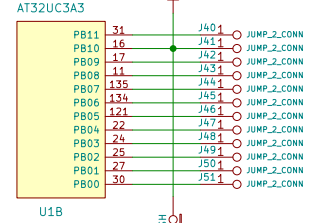
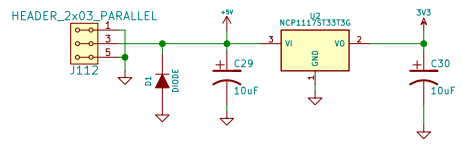
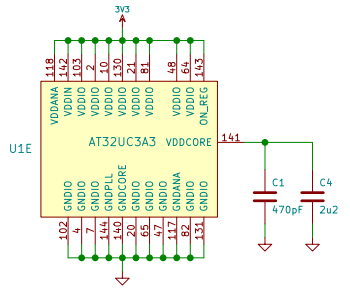

AT32UC3A3

JUMP_2_CONN	1J52	55	PX00	PX30	96	J82	JUMP_2_CONN
JUMP_2_CONN	1J53	59	PX01	PX31	97	J83	JUMP_2_CONN
JUMP_2_CONN	1J54	62	PX02	PX32	93	J84	JUMP_2_CONN
JUMP_2_CONN	1J56	63	PX03	PX33	95	J85	JUMP_2_CONN
JUMP_2_CONN	1J57	60	PX04	PX34	81	J87	JUMP_2_CONN
JUMP_2_CONN	1J58	53	PX05	PX35	38	J88	JUMP_2_CONN
JUMP_2_CONN	1J59	58	PX06	PX36	44	J86	JUMP_2_CONN
JUMP_2_CONN	1J59	54	PX07	PX37	45	J89	JUMP_2_CONN
JUMP_2_CONN	1J60	50	PX08	PX38	52	J90	JUMP_2_CONN
JUMP_2_CONN	1J61	49	PX09	PX39	52	J91	JUMP_2_CONN
JUMP_2_CONN	1J62	37	PX10	PX40	36	J92	JUMP_2_CONN
JUMP_2_CONN	1J63	67	PX11	PX41	74	J93	JUMP_2_CONN
JUMP_2_CONN	1J64	34	PX12	PX42	62	J94	JUMP_2_CONN
JUMP_2_CONN	1J65	33	PX13	PX43	88	J95	JUMP_2_CONN
JUMP_2_CONN	1J66	68	PX14	PX44	66	J96	JUMP_2_CONN
JUMP_2_CONN	1J67	40	PX15	PX45	70	J97	JUMP_2_CONN
JUMP_2_CONN	1J68	32	PX16	PX46	74	J98	JUMP_2_CONN
JUMP_2_CONN	1J69	84	PX17	PX47	39	J99	JUMP_2_CONN
JUMP_2_CONN	1J70	83	PX18	PX48	44	J100	JUMP_2_CONN
JUMP_2_CONN	1J71	35	PX19	PX49	44	J101	JUMP_2_CONN
JUMP_2_CONN	1J72	73	PX20	PX50	75	J102	JUMP_2_CONN
JUMP_2_CONN	1J73	80	PX21	PX51	77	J103	JUMP_2_CONN
JUMP_2_CONN	1J74	72	PX22	PX52	87	J104	JUMP_2_CONN
JUMP_2_CONN	1J75	85	PX23	PX53	42	J105	JUMP_2_CONN
JUMP_2_CONN	1J76	86	PX24	PX54	46	J106	JUMP_2_CONN
JUMP_2_CONN	1J77	92	PX25	PX55	79	J107	JUMP_2_CONN
JUMP_2_CONN	1J78	90	PX26	PX56	78	J108	JUMP_2_CONN
JUMP_2_CONN	1J79	89	PX27	PX57	76	J109	JUMP_2_CONN
JUMP_2_CONN	1J80	91	PX28	PX58	57	J110	JUMP_2_CONN
JUMP_2_CONN	1J81	94	PX29	PX59	56	J111	JUMP_2_CONN

U1D

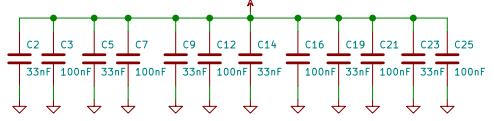
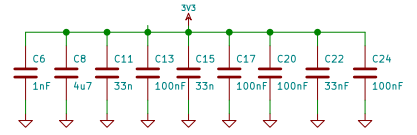
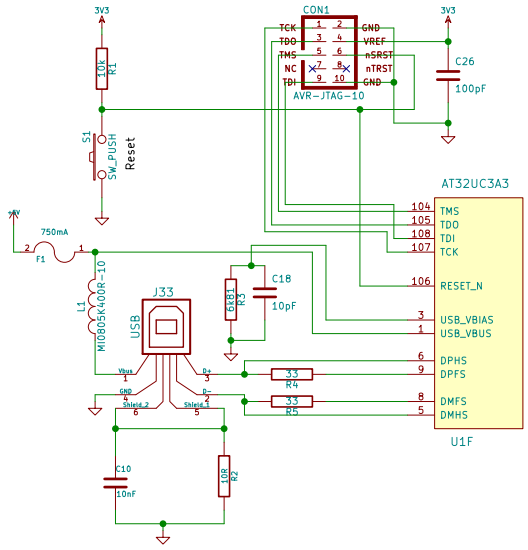
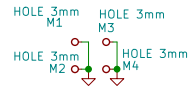

AT32UC3A3

