

### SPARE PARTS

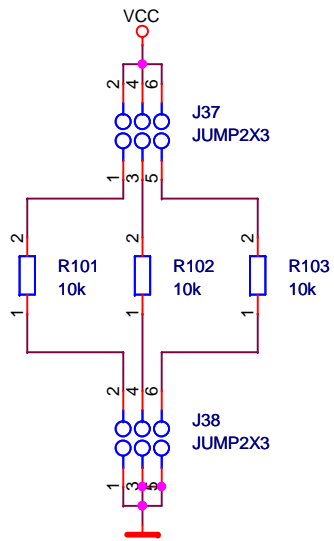

### MECHANICAL

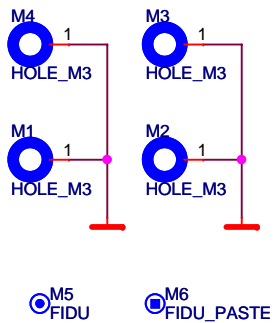

### +5V POWER

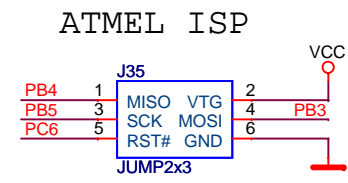
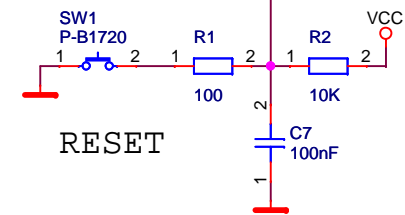
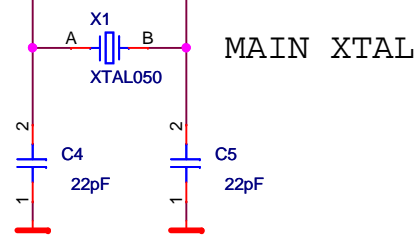
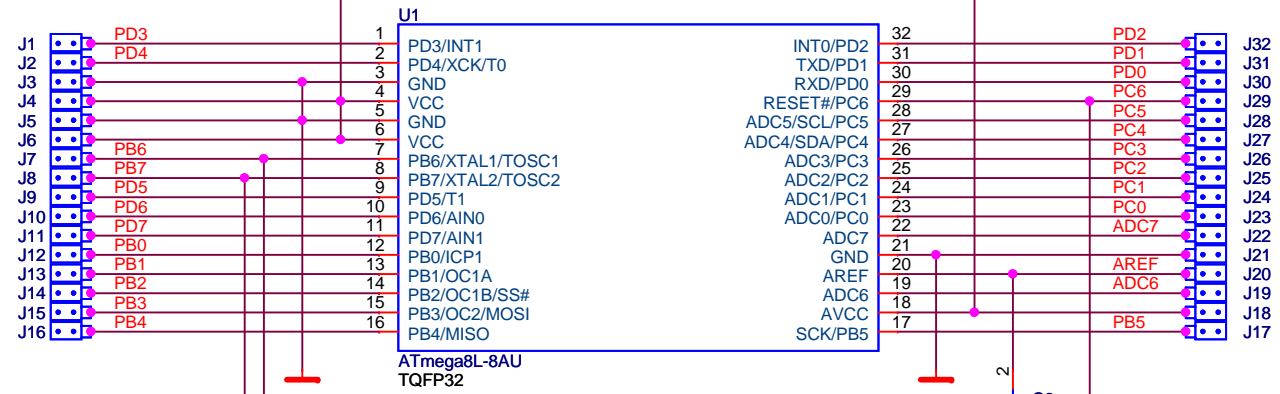
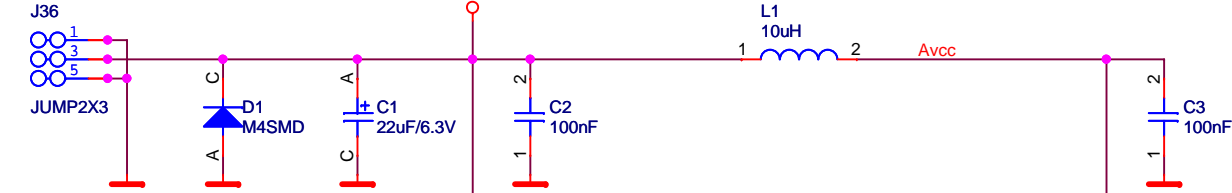

Firma			Author
<b>MLAB</b>			MIHO
Size	Project Name	Schematic Name	Rev
A4	MLAB	ATmega801B	1.00
Date:	Thursday, September 01, 2011	Sheet	2 of 2