

SPARE PARTS

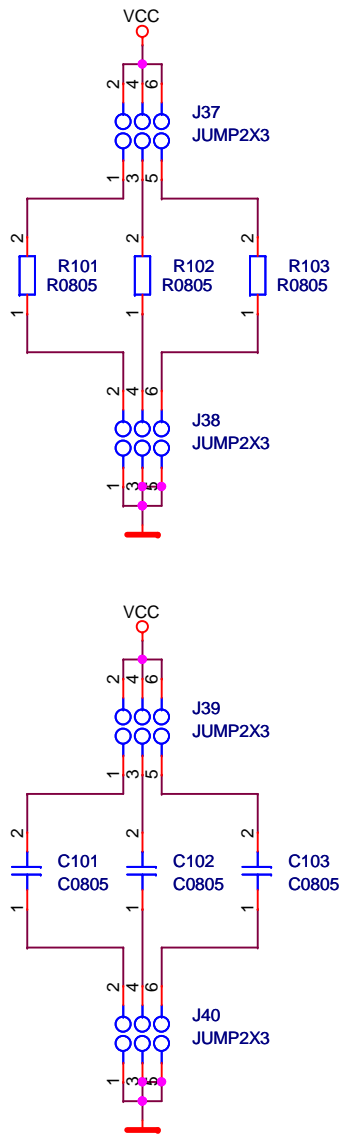

+5V POWER

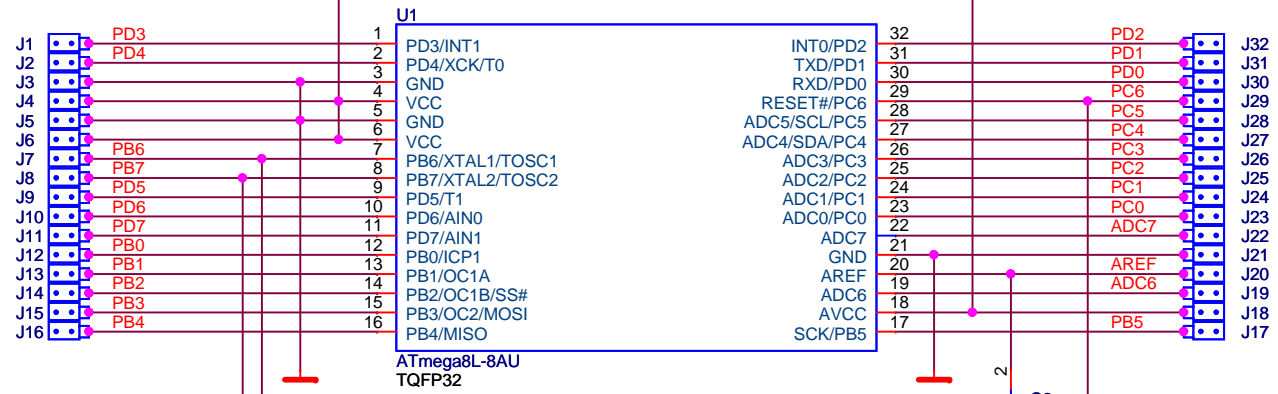
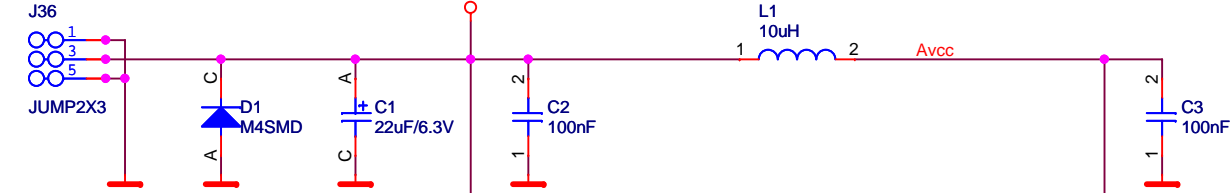

MAIN XTAL

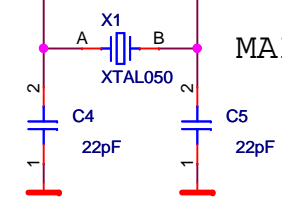

RESET

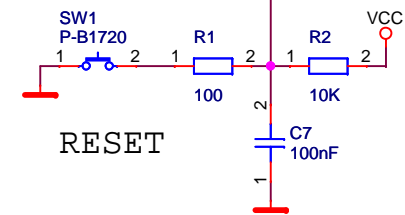

ATMEL ISP

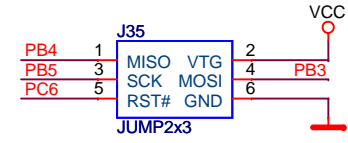

MECHANICAL

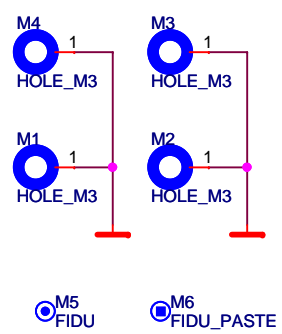

| | | | |
|-------------|----------------------------|----------------|--------|
| Firma | | Author | |
| MLAB | | MIHO | |
| Size | Project Name | Schematic Name | Rev |
| A4 | MLAB | ATmega801B | 1.00 |
| Date: | Friday, September 16, 2011 | Sheet | 2 of 2 |