

CFPS-72, -73

ISSUE 5; 19 OCTOBER 2004

Delivery Options

- Common frequencies are available from stock. Please see stock list or contact sales office

Output Compatibility

- Tri-state HCMOS/TTL (5.0V) (CFPS-72), Load 15pF max
- Tri-state HCMOS (3.3V) (CFPS-73), Load 15pF max

Package Outline

- 7.0 x 5.0mm SMD Ceramic Package.
Available over 0 to 70°C (CFPS-72, -73) or -40 to 85°C (CFPS-72I, -73I)

Standard Frequency Stabilities

- ±20ppm, ±25ppm, ±50ppm, ±100ppm (inclusive of supply voltage & output load variations over the operating temperature range)

Operating Temperature Range

- 0 to 70°C (CFPS-72, -73)
- 40 to 85°C (CFPS-72I, -73I)

Storage Temperature Range

- 55 to 125°C

Tri-state Operation

- Logic '1' to pad 1 enables oscillator output, 2.2V min
- Logic '0' to pad 1 disables oscillator output; when disabled the oscillator output goes to the high impedance state, 0.8V max
- No connection to pad 1 enables oscillator output

Solder Conditions

- For typical soldering conditions, please see the relevant pages in Applications Notes

Marking

- Model number (+ Operating Temperature Code; if applicable)
- Frequency Stability Code
- Frequency

Minimum Order Information Required

- Frequency + Model Number + Operating Temperature Code (if applicable) + Frequency Stability
- Please refer to our programmable oscillator chapter for fast make products

Outline in mm

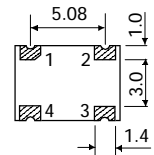
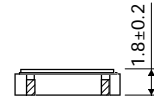
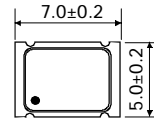

Pad Connections

- N/C or Enable/Disable
- GND
- Output
- +Vs

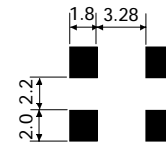

Solder pad layout

Output Waveform

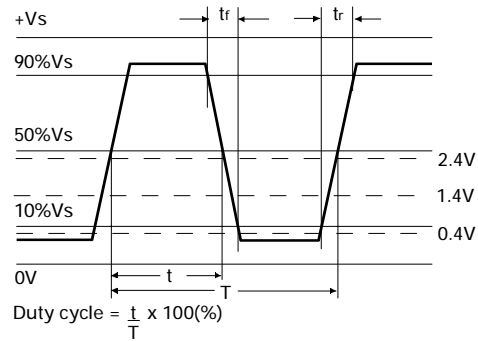

Electrical Specification - maximum limiting values when measured in HCMOS test circuit

Frequency Range	Frequency Stability	Supply Voltage	Supply Current	Rise Time(tr)	Fall Time (tf)	Duty Cycle	Model Number
1.25 to 35.0MHz	±20ppm, ±25ppm, ±50ppm, ±100ppm	3.3V	15mA	6ns	6ns	40/60%	CFPS-73, CFPS-73I
>35.0 to 70.0MHz			30mA	6ns	6ns		
>70.0 to 106.25MHz			40mA	6ns	6ns		
>106.25 to 120.0MHz			40mA	6ns	6ns		
>120.0 to 125.0MHz			40mA	6ns	6ns		
>125.0 to 160MHz	±25ppm, ±50ppm, ±100ppm	5.0V	20mA	6ns	6ns		CFPS-72, CFPS-72I
1.25 to 20.0MHz			30mA	6ns	6ns		
>20.0 to 35.0MHz			50mA	6ns	6ns		
>35.0 to 70.0MHz			70mA	6ns	6ns		
>70.0 to 100.0MHz			70mA	6ns	6ns		
>100.0 to 125.0MHz			70mA	6ns	6ns		
>125.0 to 160.0MHz			70mA	6ns	6ns		

Ordering Example
 Frequency _____ 24.0MHz _____ CFPS-73I _____ C
 Model No _____
 Operating Temperature Code: I = -40 to 85°C; Not applicable for 0 to 70°C _____
 Frequency Stability: A = ±25ppm; B = ±50ppm; C = ±100ppm; G = ±20ppm _____

Please note that the rise and fall times listed are the maximum values we specify to cover various frequency breaks. In practise the actual values are generally lower depending upon the spot frequency chosen. For typical values please contact our sales office.

Test Circuit - HCMOS

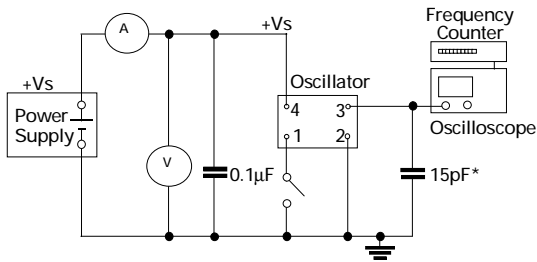

*Inclusive of jigging & equipment capacitance

Test Circuit - TTL

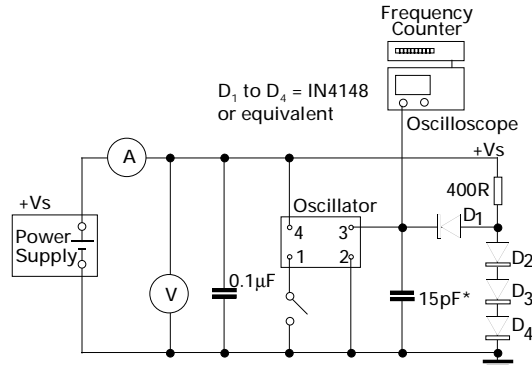

*Inclusive of jigging & equipment capacitance
 Note: CFPS-72, 72I only

ZARLINK
 APPROVED PRODUCTS

Outline in mm - Tape

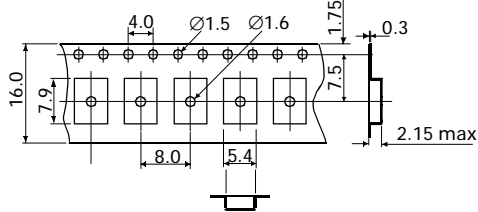

Outline in mm - Reel

