

!!! POWER 1.9V - 3.6V !!!

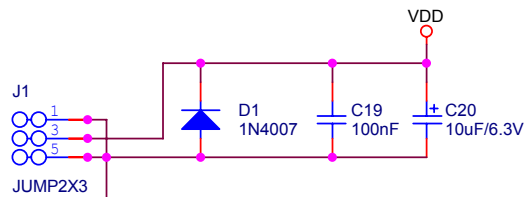

Host MCU

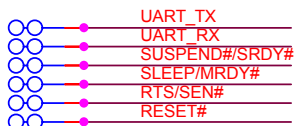

nRF24AP2

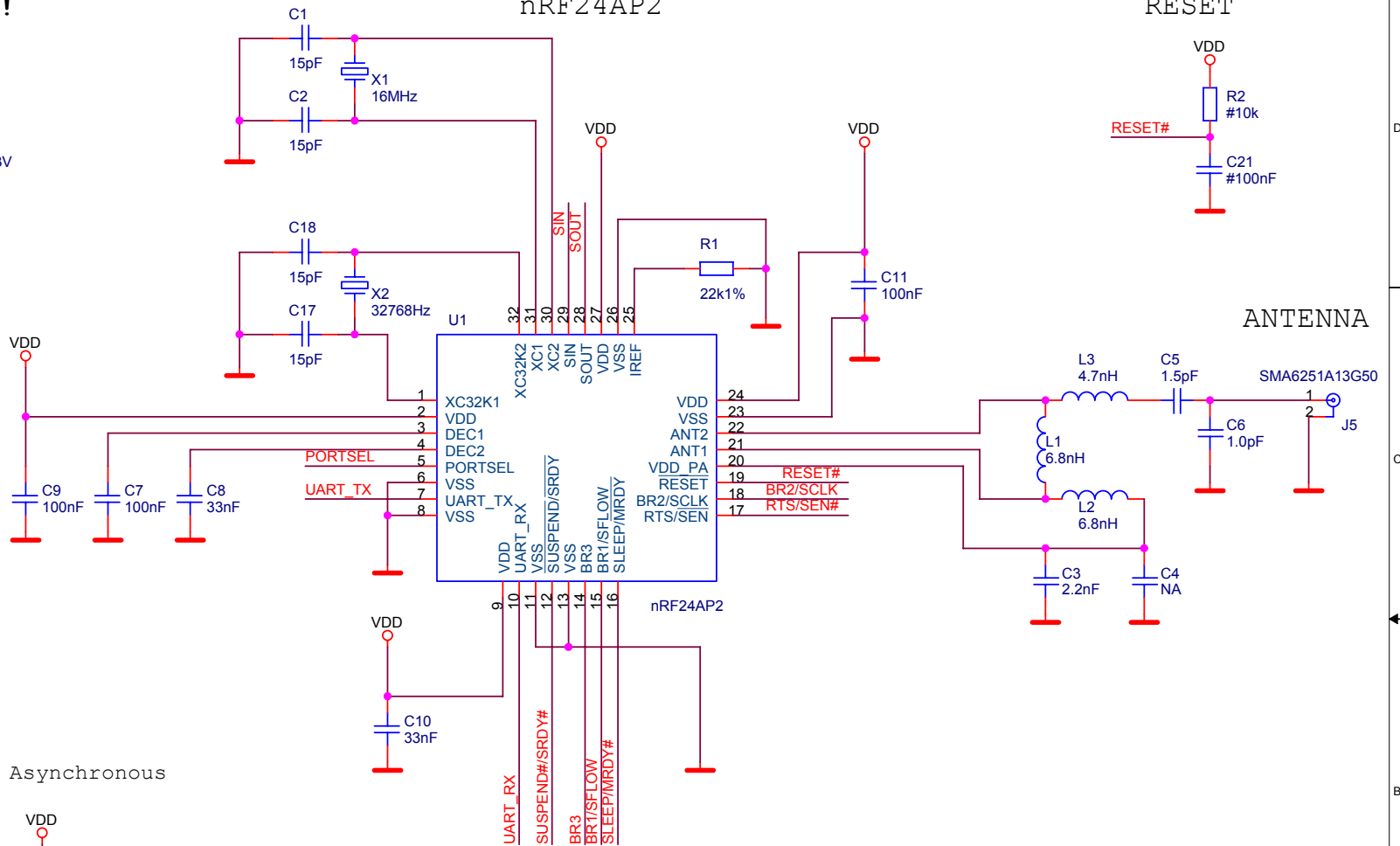

RESET

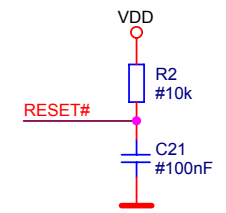

ANTENNA

PULLUP/PULLDOWN

No sleep/suspend

Asynchronous

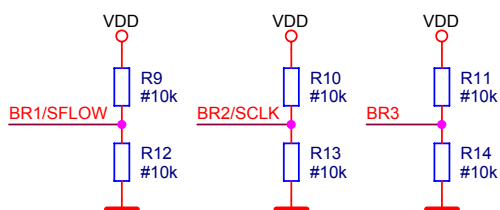
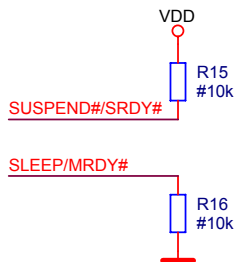

BAUD RATE

BR3	BR2	BR1	Baud rate
0	0	0	4800
0	1	0	19200
0	0	1	38400
0	1	1	50000
1	0	0	1200
1	1	0	2400
1	0	1	9600
1	1	1	57600

MECHANICAL

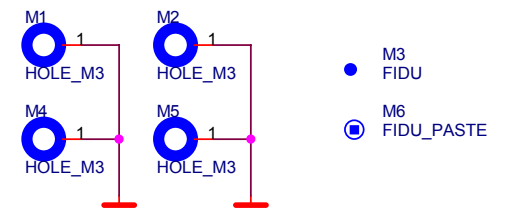

Title			ANT01		
Size	Document Number	Rev			<RevCode>
A4	<Doc>				
Date:	Thursday, January 13, 2011	Sheet	1	of	1