

### ★635nm 5mW 50°C Reliable Operation

#### • Features

1. High assembly accuracy
2. High monitor current
3. High temperature operation

#### • Applications

1. High precision measuring instruments
2. High precision industrial laser markers
3. Survey and engineering instruments

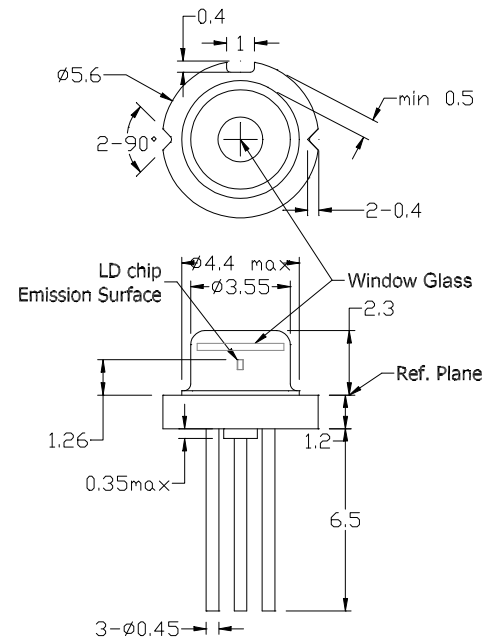

#### • Absolute maximum ratings

Parameter	Symbol	Condition	Rating	Unit
Light output power	$P_O$	CW	7	mW
Reverse voltage (LD)	$V_{RL}$	-	2	V
Reverse voltage (PD)	$V_{RD}$	-	30	V
Forward current (PD)	$I_{FD}$	-	10	mA
Case temperature	$T_C$	-	-10~+50	°C
Storage temperature	$T_S$	-	-40~+85	°C

#### • Electrical and optical characteristics ( $T_c=25^\circ\text{C}$ )

Parameter	Symbol	Min.	Typ.	Max.	Unit	Conditions
Peak wavelength	$\lambda$	630	635	640	nm	$P_o=5\text{mW}$
Threshold current	$I_{th}$	-	24	30	mA	
Operating current	$I_{op}$	-	33	40	mA	$P_o=5\text{mW}$
Operating voltage	$V_{op}$	-	2.2	2.5	V	$P_o=5\text{mW}$
Differential efficiency	$\eta$	0.4	0.6	0.8	mW/mA	$P_o=3-5\text{mW}$
Monitor current	$I_m$	0.1	0.15	0.3	mA	$P_o=5\text{mW}$ , $V_{RD}=5\text{V}$
Parallel divergence angle	$\theta_{  }$	6	7.5	11	deg	
Perpendicular divergence angle	$\theta_{\perp}$	30	33	40	deg	
Parallel FFP deviation angle	$\Delta\theta_{  }$	-2	0	+2	deg	$P_o=5\text{mW}$
Perpendicular FFP deviation angle	$\Delta\theta_{\perp}$	-2	0	+2	deg	
Emission point accuracy	$\Delta x \Delta y \Delta z$	-60	0	+60	um	

#### • Precautions

- \* Do not operate the device above maximum ratings. Doing so may cause unexpected and permanent damage to the device.
- \* Take precautions to avoid electrostatic discharge and/or momentary power spikes. A change in the characteristics of the laser or premature failure may result.
- \* Proper heat sinking of the device assures stability and lifetime. Always ensure that maximum operating temperatures are not exceeded.
- \* Observing visible or invisible laser beams with the human eye directly, or indirectly, can cause permanent damage. Use a camera to observe the laser.
- \* No laser device should be used in any application or situation where life or property is at risk in event of device failure.
- \* Specifications are subject to change without notice. Ensure that you have the latest specification by contacting us prior to purchase or use of the product.

\* For reference only. Contents above are subject to change without notice.

# AlGaInP Visible Laser Diode

**ADL-63054TL**

DATE : 2005/10/18 Ver 1.0

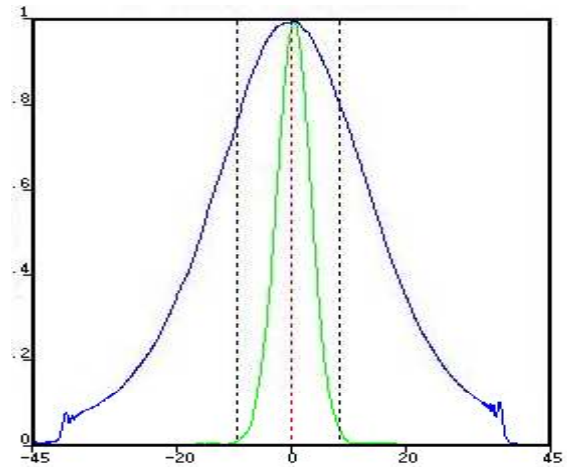
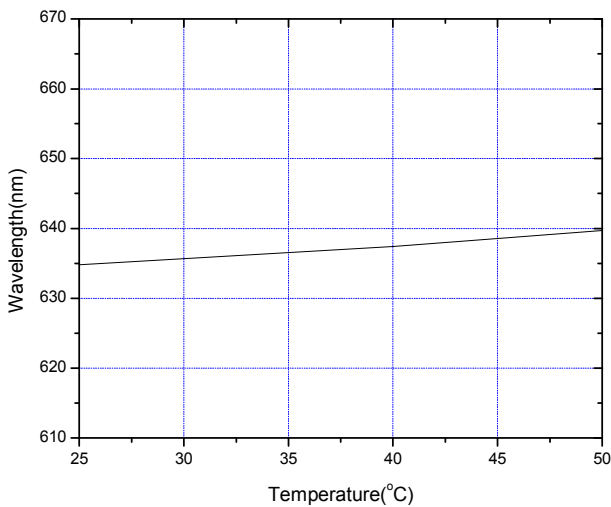
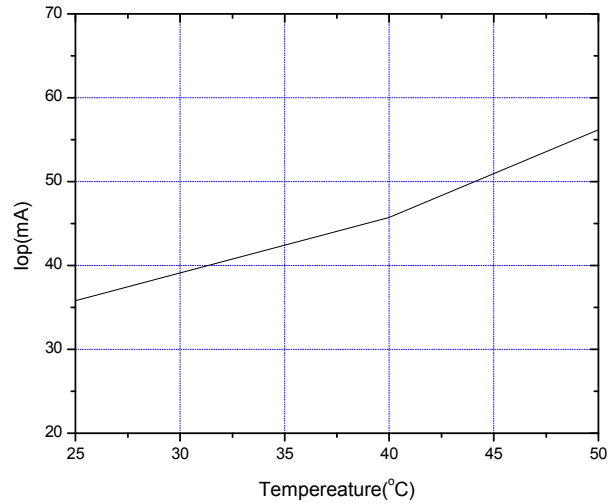
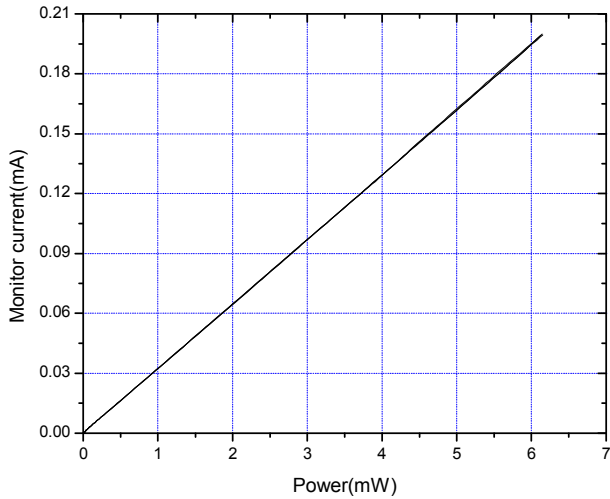
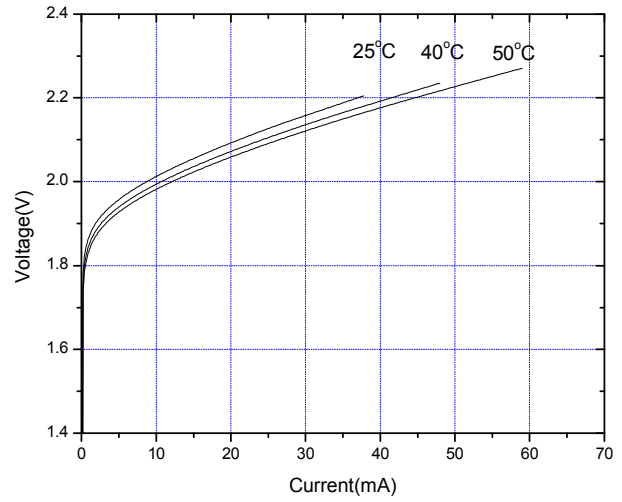
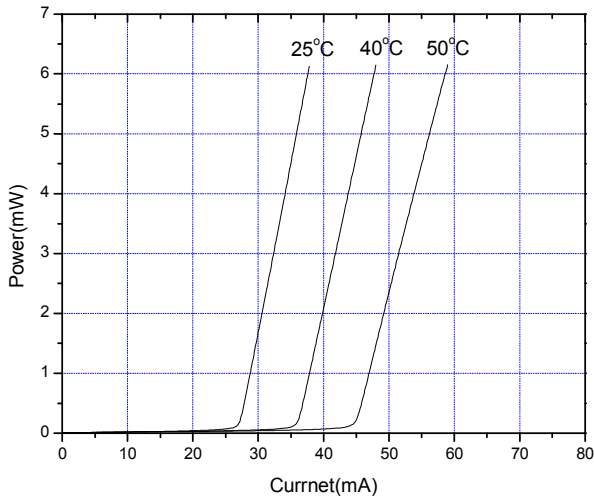

\* For reference only. Contents above are subject to change without notice.