

## 1 Using MS5534A for Barometers

Weather stations predict the change in weather by measuring the relative atmospheric pressure change over time. For the “old style” of barometers using a mechanical mechanism commonly the absolute pressure is taken as indicator for the actual weather conditions. High pressure means “good weather”, low pressure “bad weather” respectively. The zero point is 1013.25 mbar at sea level. The “normal” range of pressure change is within +/- 20mbar as can be seen on the weather chart to the right. In those charts the pressure is always calculated to the sea level of altitude. By this method the pressure chart will be independent on the landscape, especially mountains, of the region. This is because the atmospheric pressure decreases with altitude by approx. 1mbar per 10 meter at sea level. Therefore a barometer has to be calibrated to the level of altitude it is used at. In addition of this is also important that the barometer after calibration does not move in altitude. After calibration the absolute value of pressure is an indication of the actual weather condition, the relative change in pressure an indication of a future change in weather. This is feasible because a change of pressure runs always in front of a change of weather conditions. Very simple barometers measure only the relative change in pressure (i.e. 2.5 mbar) regardless of the time interval to turn on different weather symbols.



Source : Deutscher Wetterdienst, Germany

Example:

$dP > +2.5\text{mbar}$	Sun Symbol
$-2.5\text{mbar} > dP > 2.5\text{mbar}$	Sun/Cloud Symbol
$dP < -2.5\text{mbar}$	Rain Symbol

This is not a way to accurately forecast the weather since the normal pressure variations caused by temperature change during the day could already cause a variation of +/- 1-2 mbar change in pressure. Also it has been found that the pressure change during an interval of about 2-3 hours is the best indicator for a weather forecast. Therefore more sophisticated barometers measure the slope of the pressure change  $dP/dt$ .

Example:

$dP/dt > 2.5\text{mb/h}$	Intermediate High Pressure System, not stable
$0.5\text{mb/h} < dP/dt < 2.5\text{mb/h}$	Long-term High Pressure System, stable good weather
$-0.5\text{mb/h} < dP/dt < 0.5\text{mb/h}$	stable weather condition
$-2.5\text{mb/h} < dP/dt < -0.5\text{mb/h}$	Long-term Low Pressure System, stable rainy weather
$dP < -2.5\text{mb/h}$	Intermediate Low Pressure, Thunderstorm, not stable

The above algorithm is already more reliable, nevertheless it can give wrong results since it does not take into account the local terrain conditions. Close to or in the mountains for example it typically does not work since the mountains act as a climate barrier that does in most cases not reflect in the atmospheric pressure. Another example is dry regions for example in Spain, where a drop in pressure does not so easily result in clouds compared to northern European regions.

Using MS5534 for altimeters and barometers

As a conclusion of this most of the modern electronic barometers let the user decide based on his experience rather than trying to predict by a more or less sophisticated software algorithm that might be improperly adapted to the local conditions.

A commonly used method is to display a bargraph that shows the pressure development over the past few hours.

Example:

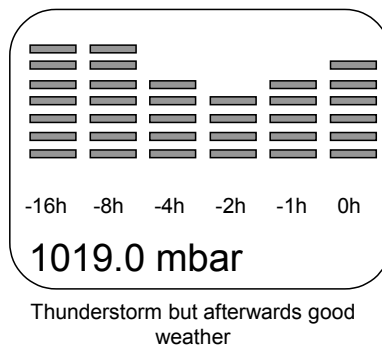
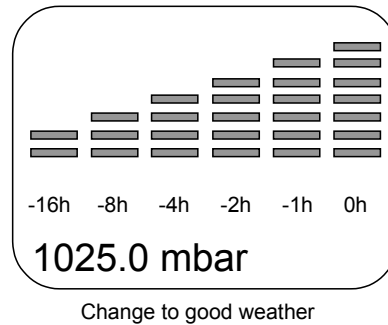
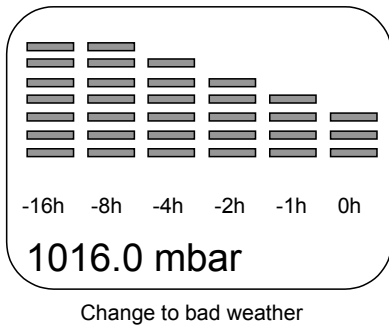
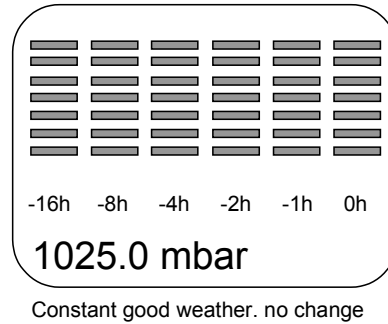
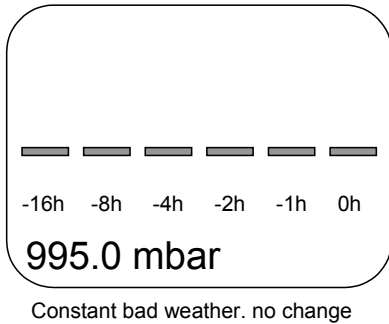
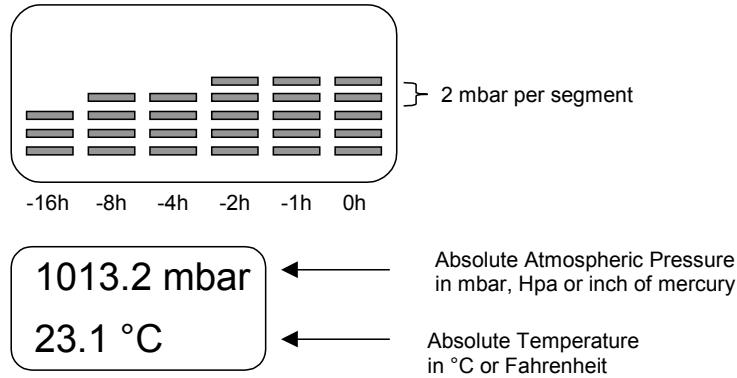

Development of the Atmospheric Pressure from 15.5. to 24.5.2000 in Bevaix, Switzerland (Altitude = 450 meter) Port Altimeter (Sensor MS5534-AM):

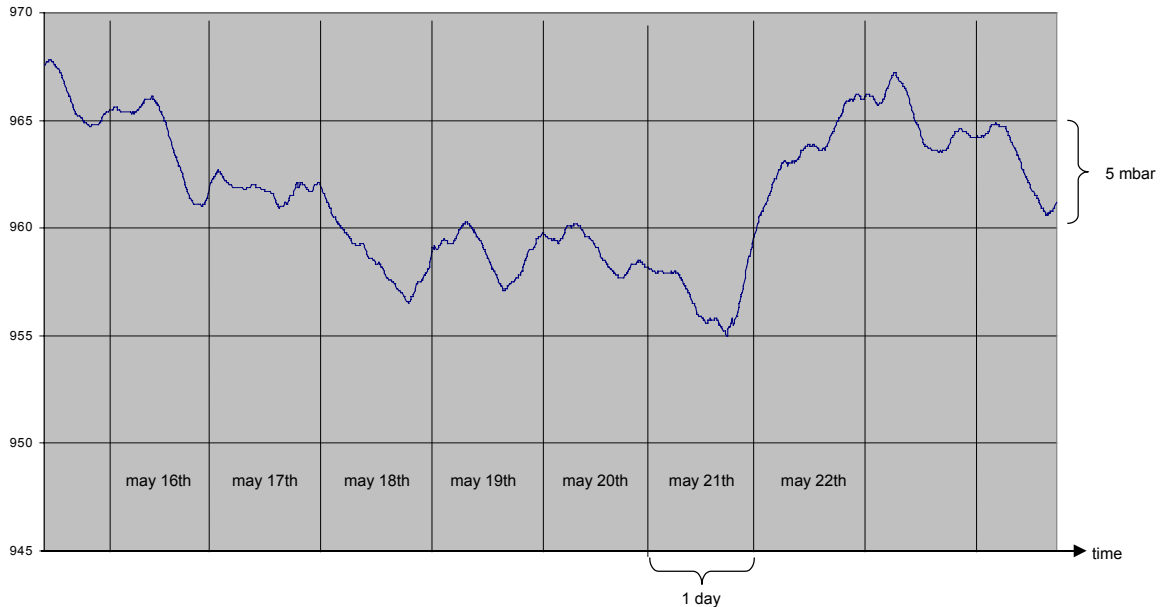

The week started with very sunny and warm weather on Monday 15.5.2000 with a pressure of 967mbar which is around 7 mbar higher than the nominal 960 mbar expected as an average at this altitude. The weather trend during the week was clearly towards bad weather. It can be noticed that during the night the pressure had a tendency to increase which is explained by the fact that the atmosphere cools down increasing the pressure on the ground.

It was finally during the weekend 20.5/21.5. that it started to rain. The pressure reached its minimum on the evening of the 21.5. at 19:42 with 955.0 mbar. Afterwards the weather changed rapidly back to sunny. The overall pressure change was only 12 mbar which is due to the fact that the deep pressure system that caused the bad weather had its center in Denmark which is around 1000km of distance to Bevaix.

In a more extreme climatic region the atmospheric change can be up to +/- 25 mbar, during the hurricane season in the Caribbean sea even up to +/- 50 mbar.

From the above it can clearly be seen that the relative pressure change alone is not good enough to predict the weather. Most of the first generation weather stations using only relative pressure would have shown a rain symbol already on the 16.5. in the above example.

It is clear that the combination of absolute pressure and relative pressure change in form of a bargraph is a more professional way to predict the weather.

It is also understandable that the pressure sensor for the barometer has to be perfectly temperature compensated. In the above example the difference in pressure was 12 mbar which is only 1.2% of the full scale range of the sensor.

For a professional barometer, the temperature stability of sensor should be better than 1 mbar over the full temperature range. Otherwise the barometer could be disturbed by sunlight in a living room (e.g. stationary barometer) or cold temperatures (e.g. watch barometer used by mountain climbers). In the case of a mountain climber this short term or temperature stability could be in an extreme situation a question of life or death.

The long-term stability of the barometer sensor on the other hand is not extremely important, because the sensor could be corrected with the local weather station in case of doubt.

The MS5534 has a temperature error of less than +/- 1 mbar (or 0.1%) over the full temperature range.

The initial offset error is specified to +/- 1.5mbar (or 0.15%).

For a barometer it is sufficient to take an average over 3 measurements (every 20 minutes) during 1 hour.

In this mode the average current consumption of the MS5534A will be below 0.5 uA.

## 2 Using MS5534A for Altimeters

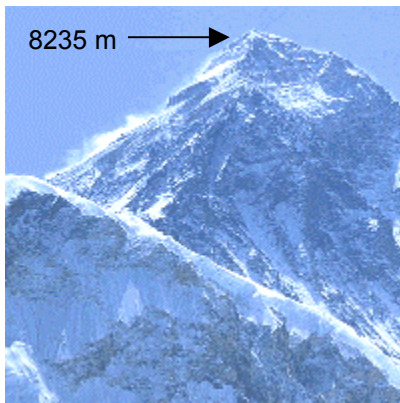

Barometers should normally stay at a certain fixed place, therefore “barometer” and “mobile” do not fit well together. The reason is that the atmospheric pressure does considerably change with altitude. At sea level the pressure decreases around 7 mbar per 100 meter in altitude. Atmospheric pressure is the weight of the atmosphere on a certain area cumulated from the altitude it is measured at up to outer space. Since air is compressible, the atmosphere gets more dense at lower altitudes where the air is more compressed. As a result the relation between pressure and altitude is a nonlinear function. At 8848 meter of altitude, which is the highest point on earth, the atmospheric pressure is around 310 mbar. An approximation of this function can be found in the US Standard Atmosphere 1976, which also takes into account a typical temperature profile of the atmosphere. The atmosphere up to 25'000m is divided into two regions: the troposphere (up to 11'000m) with a linear temperature

profile with altitude, and the lower stratosphere (from 11'000 to 25'000m) with a constant temperature. The relationship between atmospheric pressure and altitude can be used to build an altimeter with a high precision that can practically have a resolution of a few centimeters in altitude.

$$\text{Troposphere: } p = 226.5 \cdot e^{1.73 - 0.000157 \cdot h}$$

$$\text{Stratosphere: } p = 1012.9 \cdot \left( \frac{288.14 - 0.00649 \cdot h}{288.08} \right)^{5.256}$$

Pressure-to-altitude conversion (troposphere):

$$h = \frac{T_0}{T_{\text{gradient}}} \cdot \left( 1 - \left( \frac{p}{P_0} \right)^{T_{\text{gradient}} \cdot \frac{R}{g}} \right)$$

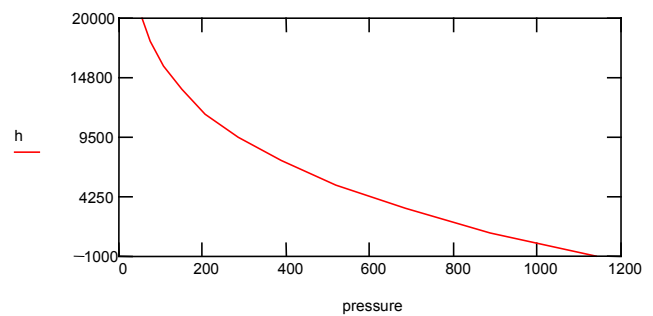

### Notes:

1976 US Standard Atmosphere is based on the assumptions:

- Zero altitude pressure  $P_0 = 101325 \text{ [Pa]} (= 1'013.25 \text{ mbar})$
- Zero altitude temperature  $T_0 = 288.15 \text{ K}$
- Temperature gradient  $T_{\text{gradient}} = 6.5/1000 \text{ [K/m]}$  in the troposphere,
- Temperature in the stratosphere =  $-56.46^\circ\text{C}$
- $R$  is the specific gas constant  $R=R^*/M_0$   $R=287.052 \text{ [J/(K * kg)]}$

100 Pa = 1 mbar

The formulas do not take into account special weather conditions like inversion weather conditions as they often appear during the winter season. They also do not take into account atmospheric pressure changes caused by changes in weather. The accumulation of the above errors can result in a total deviation of the calculated altitude of up to +/- 200 meters at sea level. Nevertheless electronic altimeters are useful instruments, because some of the errors can be corrected and weather conditions can be seen so that the experienced user will know about the accuracy of his instrument.

A common method for electronic altimeters is to adjust regularly the pressure offset at a known fix point like a lake, valley or a mountain with a known altitude.

Commercially available Altimeters normally have a display range of -1000 up to 4000, 5000 or 9000 meters. Most of the products display the altitude with 1 meter of resolution. Even more important than the resolution is the accuracy of the altimeter and especially a low error over temperature. Another important factor is the life time of the battery that is linked to the power consumption of the sensor and the display update rate of the instrument.

The following explains briefly the steps in the process of deriving a correct altitude display from the sensor output signal of the MS5534A.

### 2.1.1 Reading of Calibration Words 1-4 from the sensor

The calibration words (4 words each 16 Bit) are factory programmed and contain encoded information on tolerances of the sensor like Zero Pressure Offset, Sensitivity and so on. Those words are fix and can be read after the reset of the microcontroller in the initialization routine. The microcontroller has to calculate the coefficients C1 to C6 that are encoded in these 4 words. C1 for instance is an equivalent of the Zero Offset of the sensor. A higher value means a higher Offset voltage of the sensor.

### 2.1.2 Reading D1 and D2 (uncompensated Pressure and Temperature Value) in a loop

D1 and D2 are both 16 Bit Words. It is important to know that both values are uncompensated values. The D1 pressure value for example will not only change with pressure but also with temperature. Also the absolute value at a certain pressure is not fix but will vary from part to part. One could make a simple barometer (or altimeter) with this, but the accuracy would be poor and the temperature dependency would be large. The principle of using the MS5534 is to correct this D1 value based on the calibration coefficients C1-C6 and the D2 value in the application software.

C1 would correct for the Offset, C2 for the Sensitivity and so on.

The coefficient C6 is special. It is basically not necessary for the altimeter (or barometer) function. But as the MS5534A can also be used as a thermometer, this coefficient contains the slope of the thermometer. Same as for D1, using only D2 one could build a very poor thermometer. It is C1 and C2 that correct for the tolerances of the D2 output.

The complete compensation algorithm is shown on the next page.

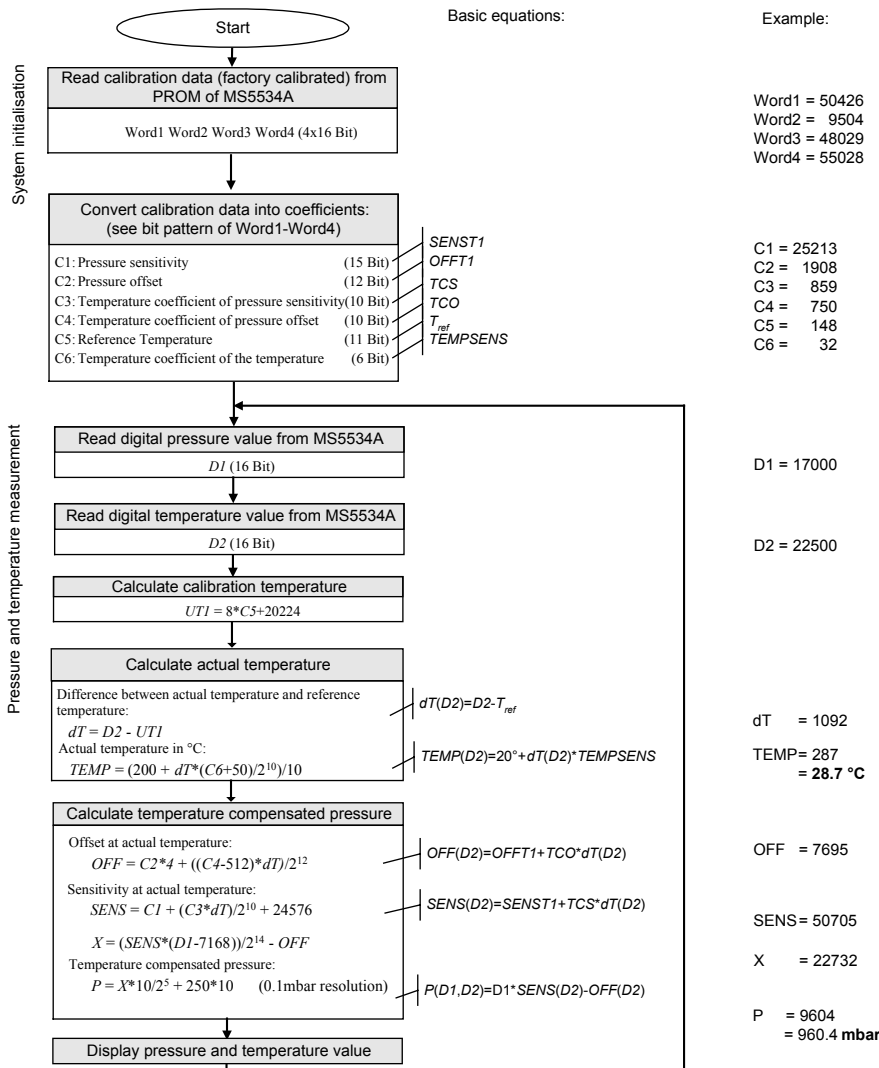

The result of the calculation is an accurate pressure value in steps of 0.1 mbar and a temperature value in steps of 0.1°C.

The loop can be performed for example every 500 msec. It is important to know that due to noise on D1, the calculated pressure value has noise of approx. +/-0.4 mbar equivalent to approx. +/- 4 meter at sea level. Therefore to get a stable display it is necessary to take an average of minimum 4 consecutive pressure values.

### 2.1.3 Filter the P value (inside the loop)

For an altimeter with 1 meter of resolution it is necessary that the noise on the pressure value is less than +/- 0.1 mbar.

The filter shall be of Low pass filter type like:

$$y_n = y_{n-1} * (1 - k) + x * k$$

Where x is the pressure calculated from the sensor's reading. y is the filtered pressure and k an amplification factor ( $k \in [0;1]$ )

Obviously, incoming pressure values should be checked against user defined min/max limits, in order to suppress possibly incorrect values. These values might occur for example when the application is started or when the sensor is turned off while acquiring data.

Example: with factor  $k = 1/8$

x=9501	$y_0 = 9501$	start value, once for initialization of the filter	
x=9500	$y_1 = 9501*0.875 + 9500*0.125 = 9500.875$	rounded 9501	Display 950.1 mbar
x=9504	$y_2 = 9501*0.875 + 9504*0.125 = 9501.375$	rounded 9501	Display 950.1 mbar
x=9502	$y_3 = 9501*0.875 + 9502*0.125 = 9501.125$	rounded 9501	Display 950.1 mbar
x=9510	$y_4 = 9501*0.875 + 9510*0.125 = 9502.125$	rounded 9502	Display 950.2 mbar
x=9512	$y_5 = 9502*0.875 + 9512*0.125 = 9503.250$	rounded 9503	Display 950.3 mbar
x=9511	$y_6 = 9503*0.875 + 9511*0.125 = 9504.554$	rounded 9505	Display 950.5 mbar

### Important:

The filtering must be done on P and not on D1 nor D2. This is due to the fact that D1 contains information about both the pressure and the temperature. Filtering D1 or D2 would reduce the efficiency of the temperature compensation.

## 2.1.4 Calculate and Display the Altitude (inside the loop)

Calculating the altitude h using directly the formula

$$h = \frac{288.15}{0.0065} \cdot \left( 1 - \left( \frac{P}{101325} \right)^{0.0065 \cdot \frac{R}{g}} \right)$$

is too complicated for a 4 or 8 Bit microcontroller, because it would require extensive floating point calculation. Instead Intersema has developed a simple formula based on a linear piecewise approximation which will give a maximum error of +/- 5 meters between -700 and 9000 meters, and a maximum error of +/- 10m between 9000 and 16000 meters. The idea of this formula is to build the two models of the troposphere and the stratosphere out of linear segments with coefficients allowing calculations without floating

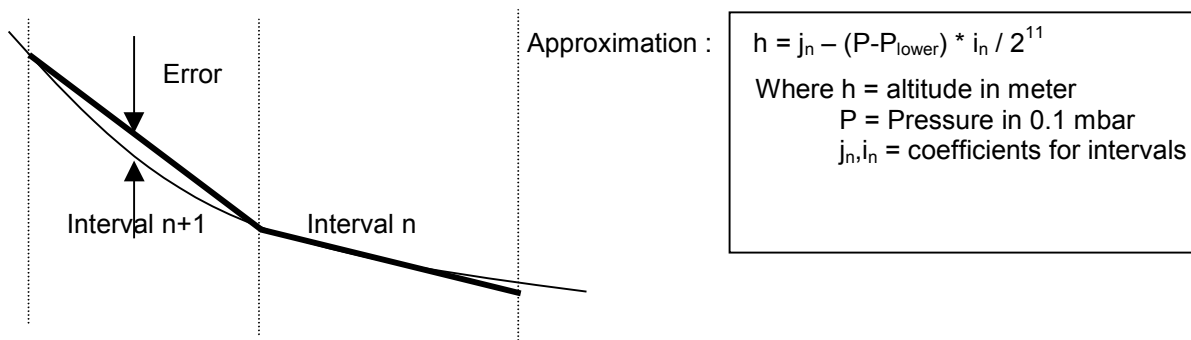



## Approximation for metric units

Pressure limits		Iteration coefficients		Examples	
$P_{\text{lower}}$ [0.1 mbar]	$P_{\text{upper}}$ [0.1 mbar]	i	j	pressure $p$ [0.1 mbar]	altitude $h$ [m]
1000	1130	12256	16212	1130	15434
1130	1300	10758	15434	1300	14541
1300	1500	9329	14541	1500	13630
1500	1730	8085	13630	1730	12722
1730	2000	7001	12722	2000	11799
2000	2300	6069	11799	2300	10910
2300	2650	5360	10910	2650	9994
2650	3000	4816	9994	3000	9171
3000	3350	4371	9171	3350	8424
3350	3700	4020	8424	3700	7737
3700	4100	3702	7737	4100	7014
4100	4500	3420	7014	4500	6346
4500	5000	3158	6346	5000	5575
5000	5500	2908	5575	5500	4865
5500	6000	2699	4865	6000	4206
6000	6500	2523	4206	6500	3590
6500	7100	2359	3590	7100	2899
7100	7800	2188	2899	7800	2151
7800	8500	2033	2151	8500	1456
8500	9200	1905	1456	9200	805
9200	9700	1802	805	9700	365
9700	10300	1720	365	10300	-139
10300	11000	1638	-139	11000	-699

**Error of the piecewise interpolation compared to the atmospheric models**

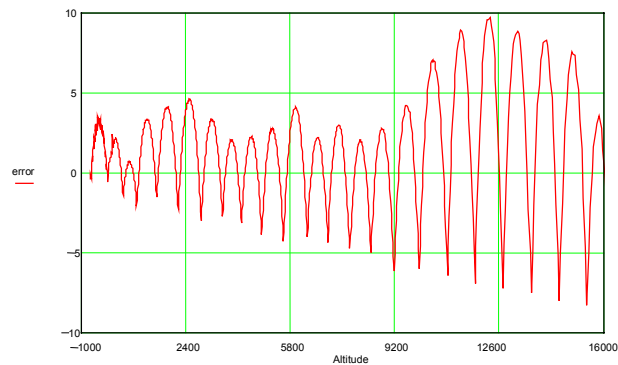



Same approximation, giving altitude in feet:

Pressure limits		Iteration coefficients		Examples	
$P_{\text{lower}}$ [0.1 mbar]	$P_{\text{upper}}$ [0.1 mbar]	i	j	pressure $p$ [0.1 mbar]	altitude $h$ [feet]
1000	1130	40220	53184	1130	50631
1130	1300	35286	50631	1300	47702
1300	1500	30597	47702	1500	44714
1500	1730	26517	44714	1730	41736
1730	2000	22960	41736	2000	38709
2000	2300	19913	38709	2300	35792
2300	2650	17584	35792	2650	32787
2650	3000	15787	32787	3000	30089
3000	3350	14354	30089	3350	27636
3350	3700	13189	27636	3700	25382
3700	4100	12145	25382	4100	23010
4100	4500	11223	23010	4500	20818
4500	5000	10351	20818	5000	18291
5000	5500	9544	18291	5500	15961
5500	6000	8860	15961	6000	13798
6000	6500	8282	13798	6500	11776
6500	7100	7735	11776	7100	9510
7100	7800	7180	9510	7800	7056
7800	8500	6679	7056	8500	4773
8500	9200	6243	4773	9200	2639
9200	9700	5915	2639	9700	1195
9700	10300	5652	1195	10300	-461
10300	11000	5375	-461	11000	-2298

**Error of the piecewise interpolation compared to the atmospheric models**

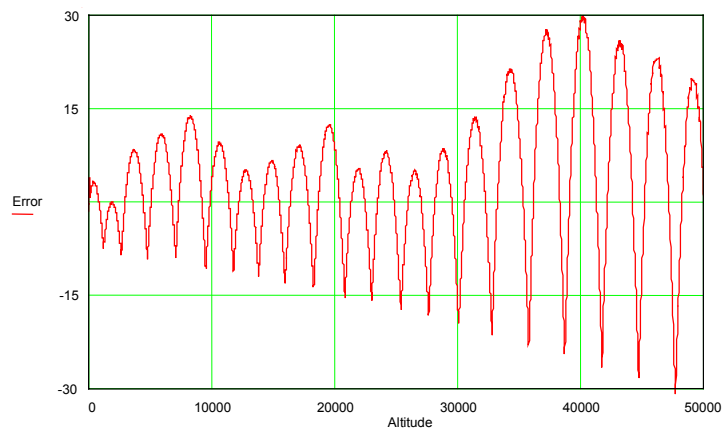

### 2.1.5 About the conversion rate (number of D1, D2 conversions per second):

In general the conversion rate should be as high as possible to give the user a feeling of an immediate response when moving the altimeter for example from a table onto the floor (which should typically result in -1 meter in altitude difference). With a higher conversion rate the filter factor can also be smaller, resulting in a higher virtual resolution. Practically one can reach a resolution of down to 30 cm taking benefit of the noise on the pressure signal of the MS5534A.

Operating the MS5534A in a continuous loop, means starting a new conversion immediately after having read the last result, would theoretically result in around 15 conversions (each D1 and D2) per second. In this case the average current consumption will be  $30 \times 5\mu\text{A} = 150\mu\text{A}$ .

If current consumption is an issue, it is better to reduce the conversion rate to for example one pair of D1/D2 per second. The response will be slower of course, depending on the filter factor used. Practical rates are between 0.5 seconds (bike computers with altitude display) and 20 seconds (low power mode for devices with small batteries).

### 2.1.6 About the display update rate:

It is better to display continuously in form of a rolling filter (like the one previously explained) instead of taking an average and then display the average.

This means it is better to display 1001m, 1002m, 1003m instead of 1000m, 3 seconds wait, 1003m

### 2.1.7 About the D2 value:

As previously mentioned it is better to do always conversion of pairs of D1, D2. The reason for this is that the D2 conversion is a kind of temperature measurement that is used to compensate for the temperature error of D1. If the D2 conversion is not done at the same time, the temperature might change in between. The result would be a wrong temperature compensation of the pressure value.

#### **Example:**

- Temperature gradient =  $1^\circ\text{C}/\text{second}$  (for example due to heat up of the RF stage inside a mobile phone)
- Temperature gradient of D1 value =  $-0.2\%/^\circ\text{C}$  (this is the temperature coefficient of an uncompensated sensor)
- Time difference between conversion of D1 and D2 = 1 sec

⇒ Error on Pressure at 1000 mbar =  $-0.2\%$  of 1000mbar = -2 mbar = approx. -20 meters

### 2.1.8 Using MS5534A as thermometer:

The MS5534A can be used as a high resolution thermometer with an resolution of down to  $0.015^\circ\text{C}$  ! The sensing element is the pressure sensor located inside the metal or plastic cap of the MS5534A.

For low power devices like bike computers the sensor can therefore accurately sense the ambient temperature in the range between  $-10$  to  $+60^\circ\text{C}$ .

For wrist watches it is not so simple as the human body will heat up the watch with the sensor inside. Same applies for devices with high current consumption like GPS receivers or mobile phones that will heat up due to the RF power stages.

### 3 Recommendation for use of MS5534A in the final product

The MS5534 is basically simple to use, as beside a block capacitor no external components are required to operate the device. The output signal is digital and the controlling processor is the master. This means the software programmer can define at what speed he likes to read out the data from the sensor. Nevertheless some precautions have to be taken to get optimum results:

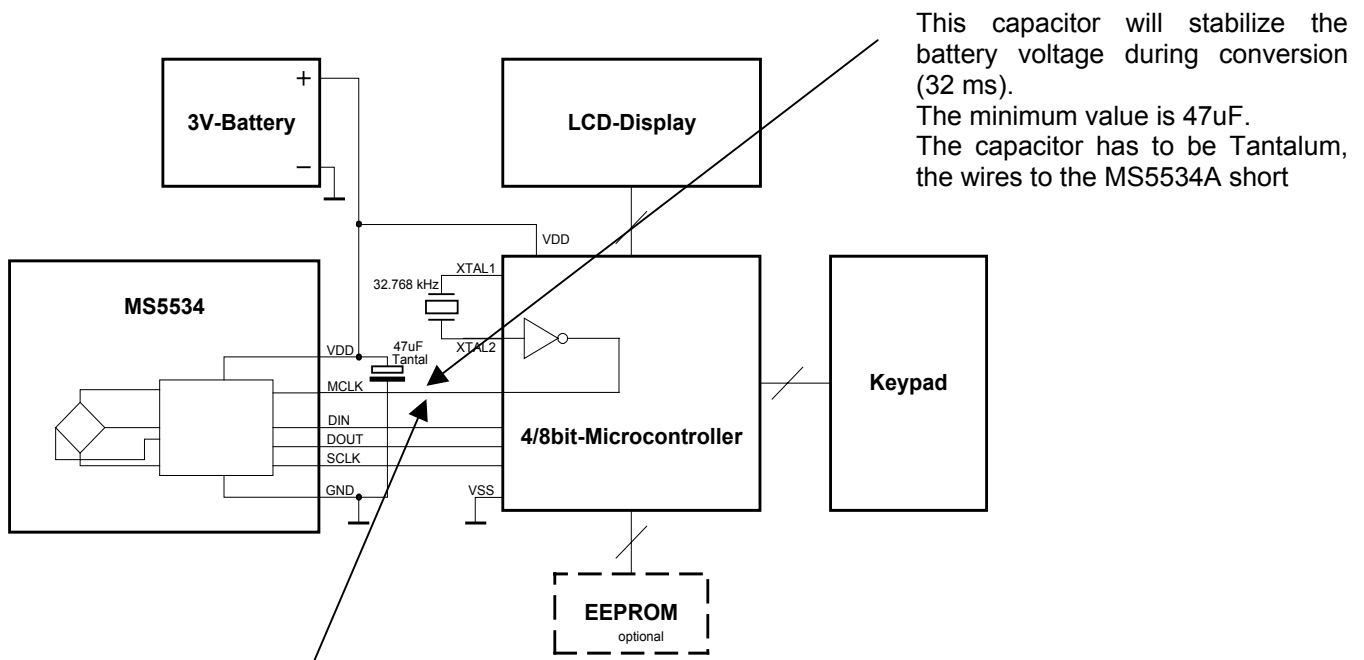

The MCLK signal has to be logic level and jitter free. It is used for the A/D converter and has to be 32768Hz. Higher or lower frequencies will result in noise and increased linearity error of the sensor

During operation the sensor is sensitive to direct light. Inside the application it should be placed in a dark place

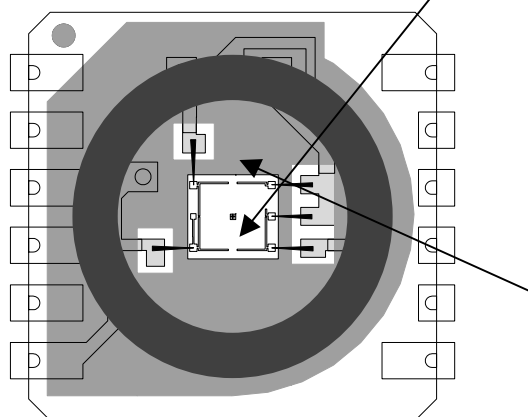

The sensor is protected by a drop of silicone gel. Nevertheless direct water contact might change the sensor properties over time

---

**REVISION HISTORY**

---

Date	Revision	Type of changes
April 24, 2002	V1.0	
August 6, 2003	V2.0	Pressure to altitude conversion updates (addition of troposphere and stratosphere formulas)

---

**FACTORY CONTACTS**

---

Intersema Sensoric SA Ch. Chapons-des-Prés 11 CH-2022 BEVAIX  SWITZERLAND	Tel. (032) 847 9550 Tel. Int. +41 32 847 9550 Telefax +41 32 847 9569 e-mail: <a href="mailto:sales@intersema.ch">sales@intersema.ch</a> <a href="http://www.intersema.ch">http://www.intersema.ch</a>
---	--

**NOTICE**

Intersema reserves the right to make changes to the products contained in this document in order to improve the design or performance and to supply the best possible products. Intersema assumes no responsibility for the use of any circuits shown in this document, conveys no license under any patent or other rights unless otherwise specified in this document, and makes no claim that the circuits are free from patent infringement. Applications for any devices shown in this document are for illustration only and Intersema makes no claim or warranty that such applications will be suitable for the use specified without further testing or modification.