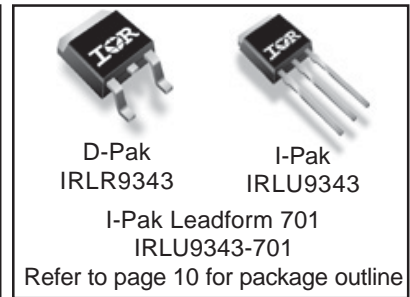
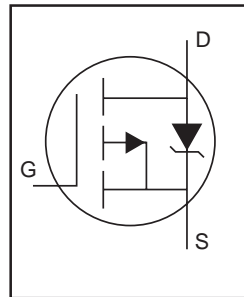


**Features**

- Advanced Process Technology
- Key Parameters Optimized for Class-D Audio Amplifier Applications
- Low  $R_{DS(ON)}$  for Improved Efficiency
- Low  $Q_g$  and  $Q_{sw}$  for Better THD and Improved Efficiency
- Low  $Q_{rr}$  for Better THD and Lower EMI
- 175°C Operating Junction Temperature for Ruggedness
- Repetitive Avalanche Capability for Robustness and Reliability
- Multiple Package Options
- Lead-Free

Key Parameters		
$V_{DS}$	-55	V
$R_{DS(ON)}$ typ. @ $V_{GS} = -10V$	93	mΩ
$R_{DS(ON)}$ typ. @ $V_{GS} = -4.5V$	150	mΩ
$Q_g$ typ.	31	nC
$T_J$ max	175	°C



**Description**

This Digital Audio HEXFET<sup>®</sup> is specifically designed for Class-D audio amplifier applications. This MosFET utilizes the latest processing techniques to achieve low on-resistance per silicon area. Furthermore, Gate charge, body-diode reverse recovery and internal Gate resistance are optimized to improve key Class-D audio amplifier performance factors such as efficiency, THD and EMI. Additional features of this MosFET are 175°C operating junction temperature and repetitive avalanche capability. These features combine to make this MosFET a highly efficient, robust and reliable device for Class-D audio amplifier applications.

**Absolute Maximum Ratings**

	Parameter	Max.	Units
$V_{DS}$	Drain-to-Source Voltage	-55	V
$V_{GS}$	Gate-to-Source Voltage	±20	
$I_D$ @ $T_C = 25^\circ C$	Continuous Drain Current, $V_{GS}$ @ -10V	-20	A
$I_D$ @ $T_C = 100^\circ C$	Continuous Drain Current, $V_{GS}$ @ 10V	-14	
$I_{DM}$	Pulsed Drain Current ①	-60	
$P_D$ @ $T_C = 25^\circ C$	Power Dissipation	79	W
$P_D$ @ $T_C = 100^\circ C$	Power Dissipation	39	
	Linear Derating Factor	0.53	W/°C
$T_J$	Operating Junction and	-40 to + 175	°C
$T_{STG}$	Storage Temperature Range		
	Clamping Pressure ⑥	—	N

**Thermal Resistance**

	Parameter	Typ.	Max.	Units
$R_{\theta JC}$	Junction-to-Case ⑤	—	1.9	
$R_{\theta JA}$	Junction-to-Ambient (PCB Mounted) ⑤⑧	—	50	°C/W
$R_{\theta JA}$	Junction-to-Ambient (free air) ⑤	—	110	

Notes ① through ⑨ are on page 10

## Electrical Characteristics @ $T_J = 25^\circ\text{C}$ (unless otherwise specified)

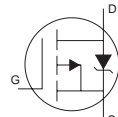
	Parameter	Min.	Typ.	Max.	Units	Conditions
$BV_{DSS}$	Drain-to-Source Breakdown Voltage	-55	—	—	V	$V_{GS} = 0V, I_D = -250\mu A$
$\Delta BV_{DSS}/\Delta T_J$	Breakdown Voltage Temp. Coefficient	—	-52	—	mV/°C	Reference to $25^\circ\text{C}, I_D = -1\text{mA}$
$R_{DS(on)}$	Static Drain-to-Source On-Resistance	—	93	105	mΩ	$V_{GS} = -10V, I_D = -3.4A$ ③
		—	150	170		$V_{GS} = -4.5V, I_D = -2.7A$ ③
$V_{GS(th)}$	Gate Threshold Voltage	-1.0	—	—	V	$V_{DS} = V_{GS}, I_D = -250\mu A$
$\Delta V_{GS(th)}/\Delta T_J$	Gate Threshold Voltage Coefficient	—	-3.7	—	mV/°C	
$I_{DSS}$	Drain-to-Source Leakage Current	—	—	-2.0	μA	$V_{DS} = -55V, V_{GS} = 0V$
		—	—	-25		$V_{DS} = -55V, V_{GS} = 0V, T_J = 125^\circ\text{C}$
$I_{GSS}$	Gate-to-Source Forward Leakage	—	—	-100	nA	$V_{GS} = -20V$
	Gate-to-Source Reverse Leakage	—	—	100		$V_{GS} = 20V$
$g_{fs}$	Forward Transconductance	5.3	—	—	S	$V_{DS} = -25V, I_D = -14A$
$Q_g$	Total Gate Charge	—	31	47		$V_{DS} = -44V$ $V_{GS} = -10V$ $I_D = -14A$ See Fig. 6 and 19
$Q_{gs}$	Gate-to-Source Charge	—	7.1	—		
$Q_{gd}$	Gate-to-Drain Charge	—	8.5	—		
$Q_{godr}$	Gate Charge Overdrive	—	15	—		
$t_{d(on)}$	Turn-On Delay Time	—	9.5	—	ns	$V_{DD} = -28V, V_{GS} = -10V$ ③ $I_D = -14A$ $R_G = 2.5\Omega$
$t_r$	Rise Time	—	24	—		
$t_{d(off)}$	Turn-Off Delay Time	—	21	—		
$t_f$	Fall Time	—	9.5	—		
$C_{iss}$	Input Capacitance	—	660	—	pF	$V_{GS} = 0V$ $V_{DS} = -50V$ $f = 1.0\text{MHz}$ , See Fig. 5 $V_{GS} = 0V, V_{DS} = 0V$ to $-44V$
$C_{oss}$	Output Capacitance	—	160	—		
$C_{rss}$	Reverse Transfer Capacitance	—	72	—		
$C_{oss}$	Effective Output Capacitance	—	280	—		
$L_D$	Internal Drain Inductance	—	4.5	—	nH	Between lead, 6mm (0.25in.) from package and center of die contact ④
$L_S$	Internal Source Inductance	—	7.5	—		

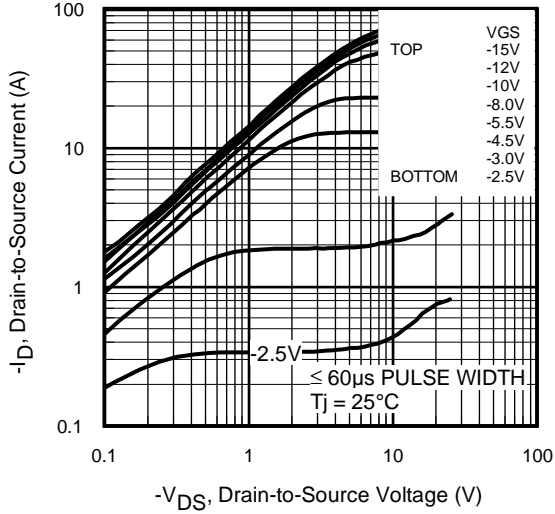
## Avalanche Characteristics

	Parameter	Typ.	Max.	Units
$E_{AS}$	Single Pulse Avalanche Energy ②	—	120	mJ
$I_{AR}$	Avalanche Current ⑦	See Fig. 14, 15, 17a, 17b		A
$E_{AR}$	Repetitive Avalanche Energy ⑦			mJ

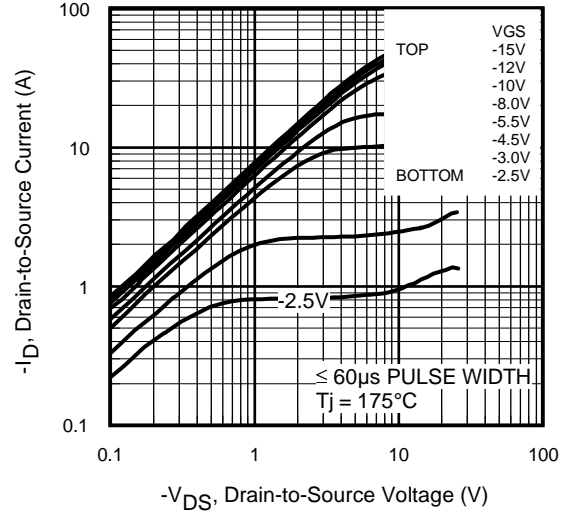
## Diode Characteristics

	Parameter	Min.	Typ.	Max.	Units	Conditions
$I_S @ T_C = 25^\circ\text{C}$	Continuous Source Current (Body Diode)	—	—	-20	A	MOSFET symbol showing the integral reverse p-n junction diode.
$I_{SM}$	Pulsed Source Current (Body Diode) ①	—	—	-60		
$V_{SD}$	Diode Forward Voltage	—	—	-1.2	V	$T_J = 25^\circ\text{C}, I_S = -14A, V_{GS} = 0V$ ③
$t_{rr}$	Reverse Recovery Time	—	57	86	ns	$T_J = 25^\circ\text{C}, I_F = -14A$
$Q_{rr}$	Reverse Recovery Charge	—	120	180	nC	$di/dt = 100A/\mu s$ ③

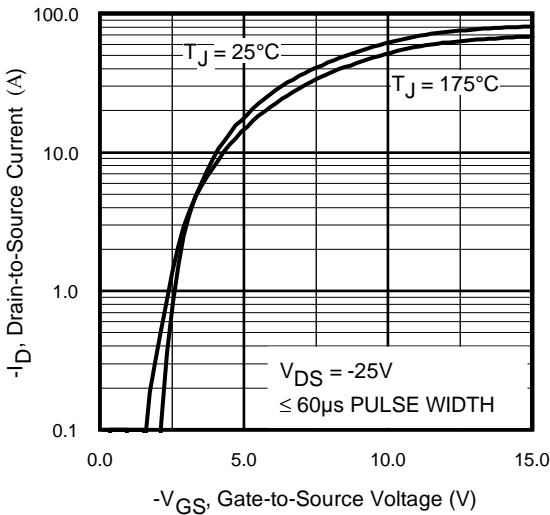




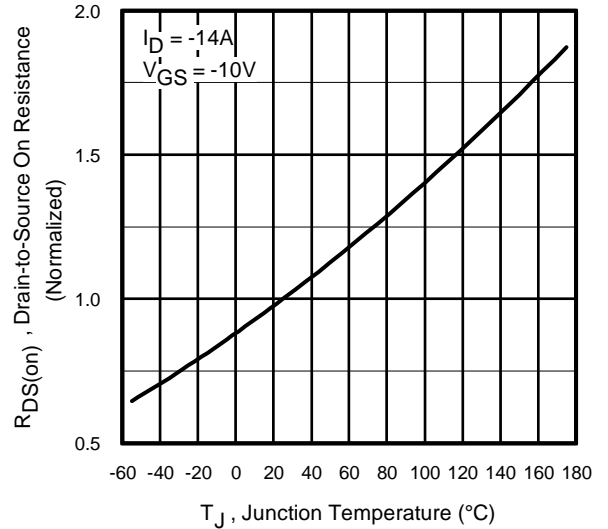
**Fig 1.** Typical Output Characteristics



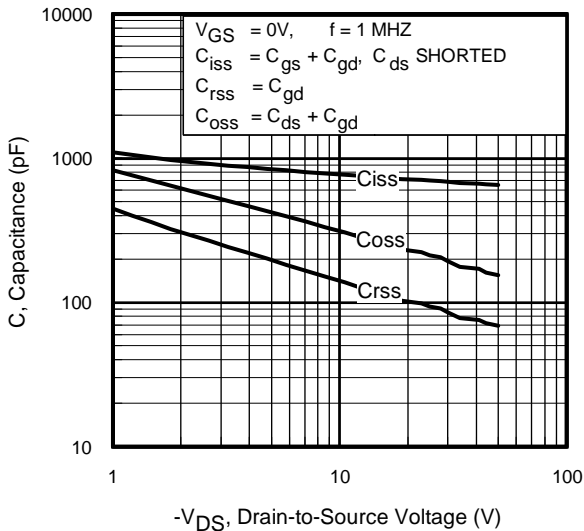
**Fig 2.** Typical Output Characteristics



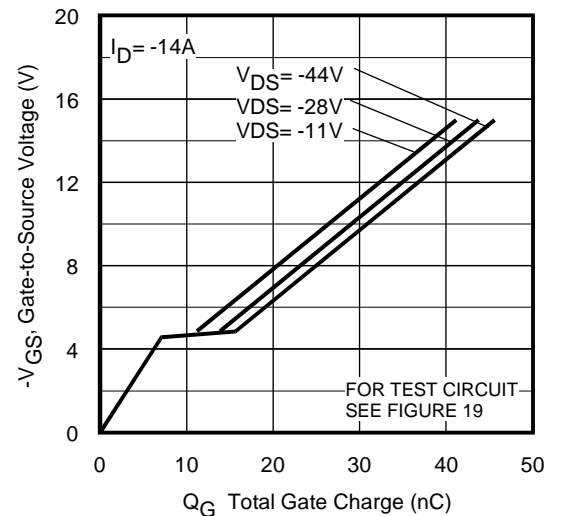
**Fig 3.** Typical Transfer Characteristics



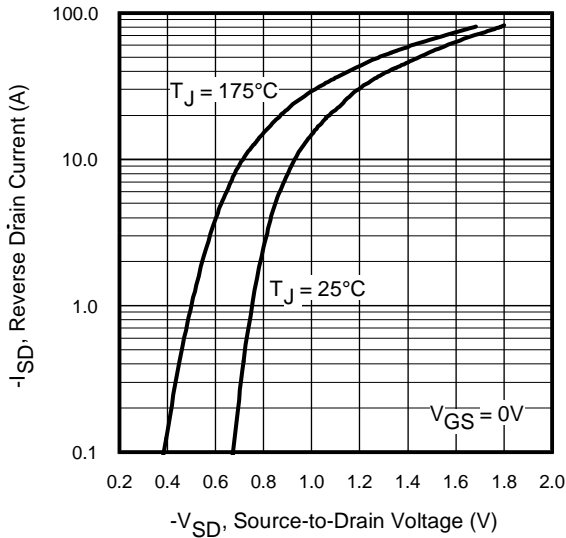
**Fig 4.** Normalized On-Resistance vs. Temperature



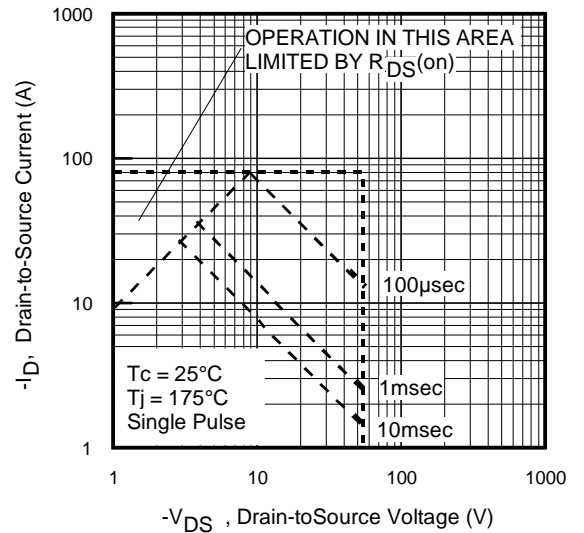
**Fig 5.** Typical Capacitance vs. Drain-to-Source Voltage  
www.irf.com



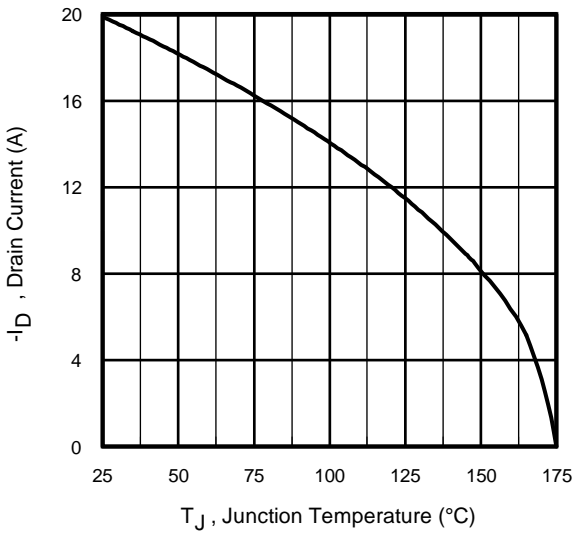
**Fig 6.** Typical Gate Charge vs. Gate-to-Source Voltage



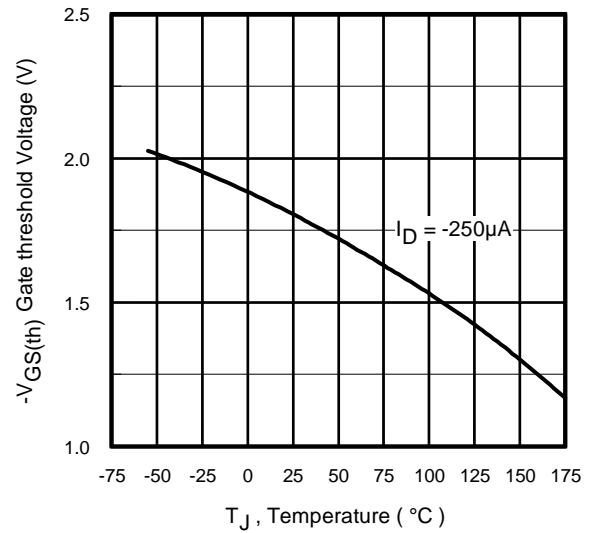
**Fig 7.** Typical Source-Drain Diode Forward Voltage



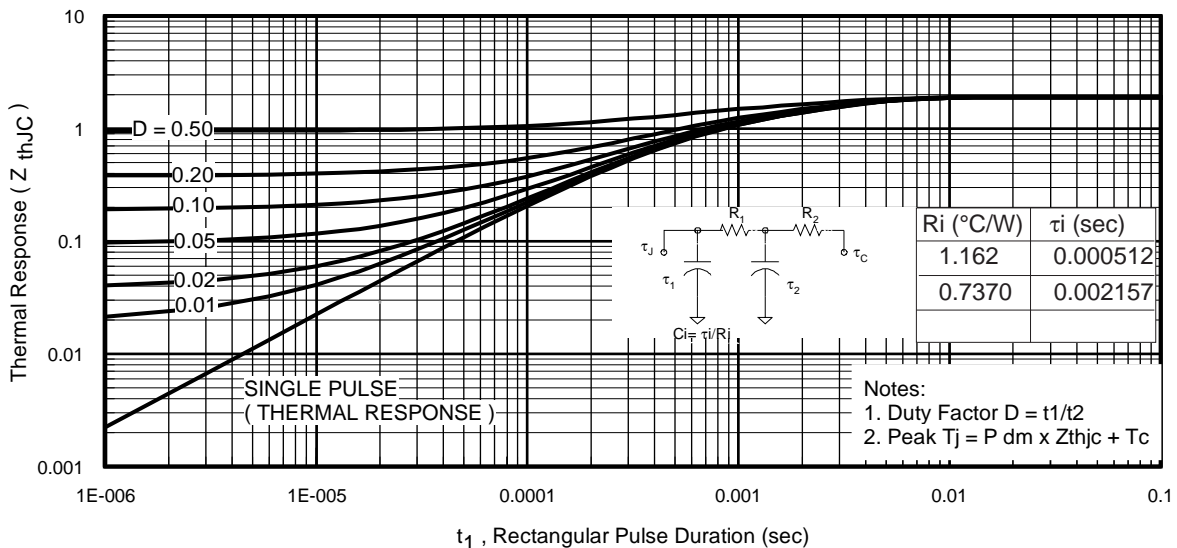
**Fig 8.** Maximum Safe Operating Area



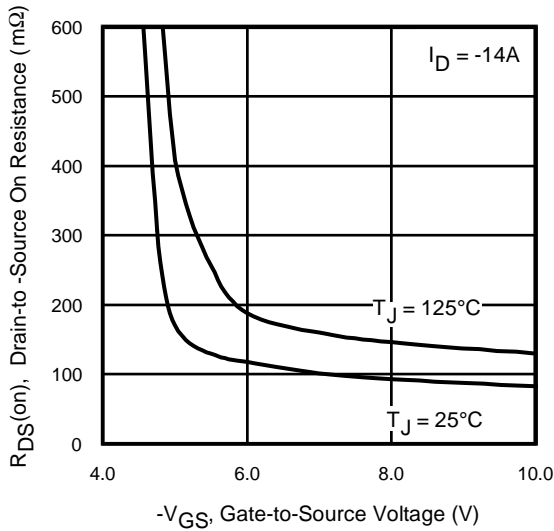
**Fig 9.** Maximum Drain Current vs. Case Temperature



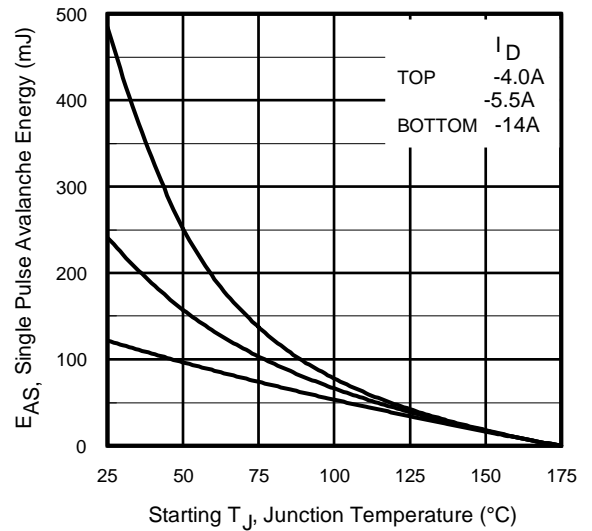
**Fig 10.** Threshold Voltage vs. Temperature



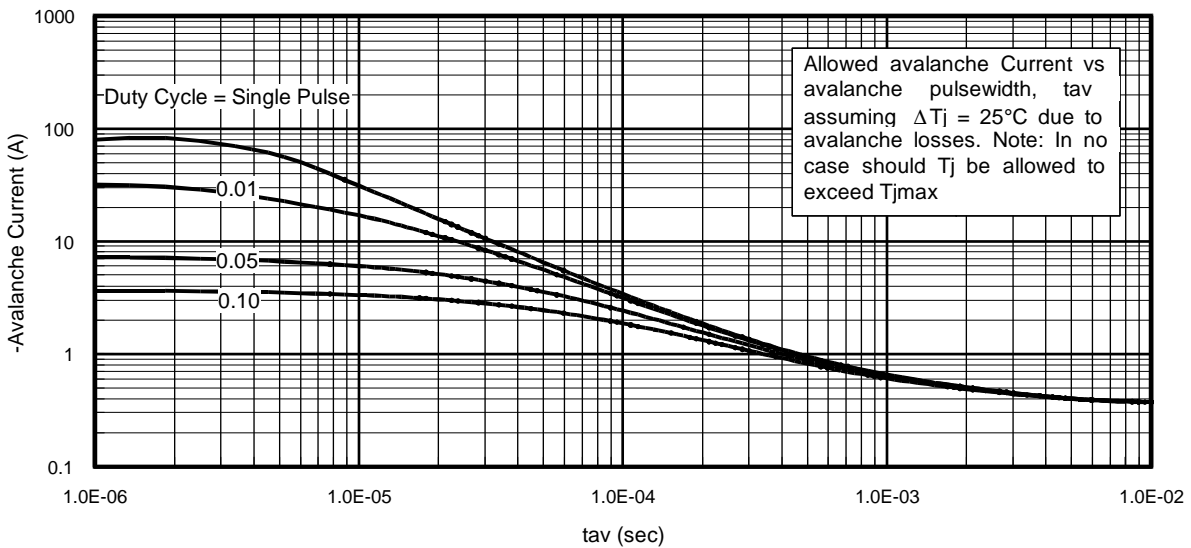
**Fig 11.** Maximum Effective Transient Thermal Impedance, Junction-to-Case



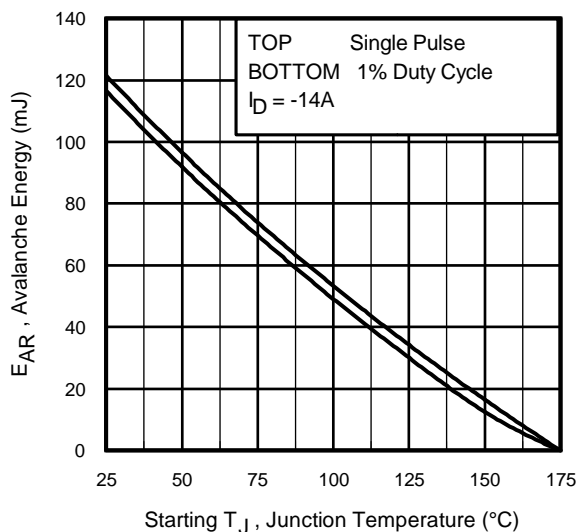
**Fig 12.** On-Resistance Vs. Gate Voltage



**Fig 13.** Maximum Avalanche Energy Vs. Drain Current



**Fig 14.** Typical Avalanche Current Vs. Pulsewidth



**Fig 15.** Maximum Avalanche Energy Vs. Temperature

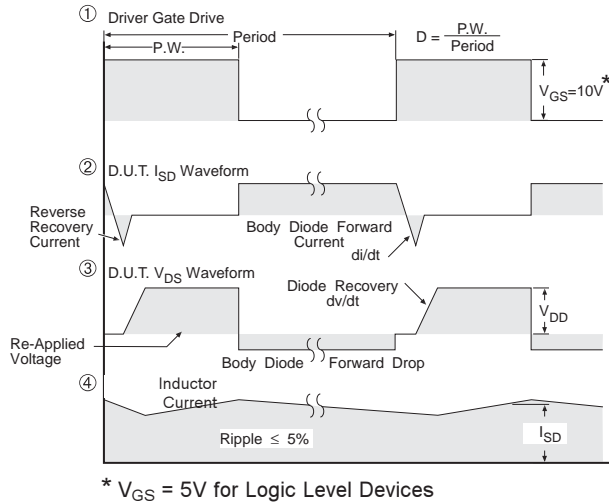
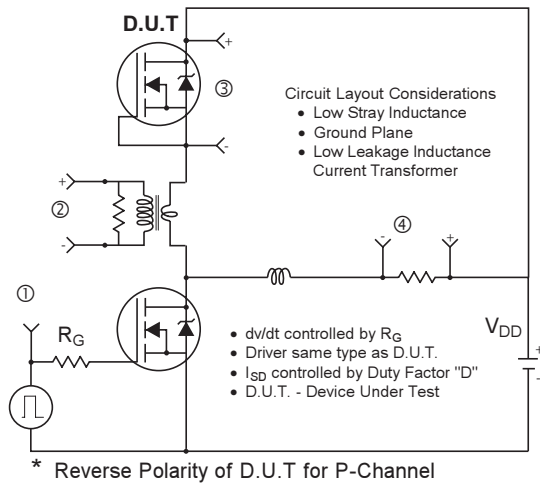
**Notes on Repetitive Avalanche Curves , Figures 14, 15:**  
(For further info, see AN-1005 at [www.irf.com](http://www.irf.com))

1. Avalanche failures assumption:  
Purely a thermal phenomenon and failure occurs at a temperature far in excess of  $T_{jmax}$ . This is validated for every part type.
2. Safe operation in Avalanche is allowed as long as  $T_{jmax}$  is not exceeded.
3. Equation below based on circuit and waveforms shown in Figures 17a, 17b.
4.  $P_{D(ave)}$  = Average power dissipation per single avalanche pulse.
5.  $BV$  = Rated breakdown voltage (1.3 factor accounts for voltage increase during avalanche).
6.  $I_{av}$  = Allowable avalanche current.
7.  $\Delta T$  = Allowable rise in junction temperature, not to exceed  $T_{jmax}$  (assumed as 25°C in Figure 14, 15).  
 $t_{av}$  = Average time in avalanche  
 $D$  = Duty cycle in avalanche =  $t_{av} \cdot f$   
 $Z_{thJC}(D, t_{av})$  = Transient thermal resistance, see figure 11)

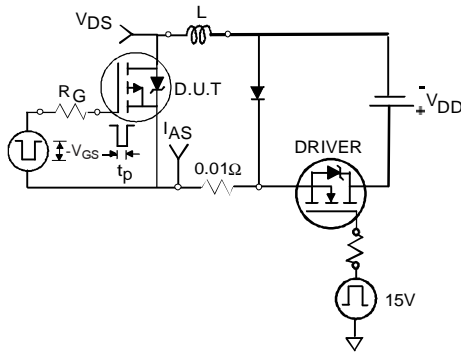
$$P_{D(ave)} = 1/2 ( 1.3 \cdot BV \cdot I_{av} ) = \Delta T / Z_{thJC}$$

$$I_{av} = 2\Delta T / [1.3 \cdot BV \cdot Z_{th}]$$

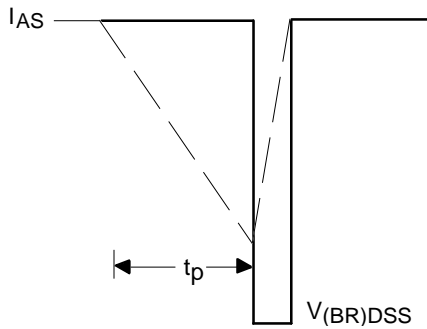
$$E_{AS(AR)} = P_{D(ave)} \cdot t_{av}$$



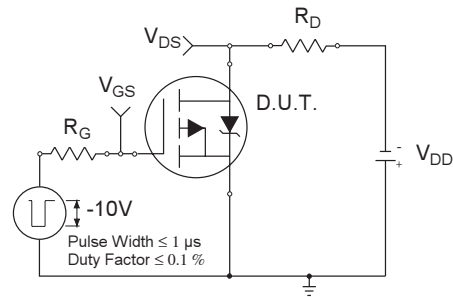
**Fig 16. Peak Diode Recovery  $dv/dt$  Test Circuit for P-Channel HEXFET<sup>®</sup> Power MOSFETs**



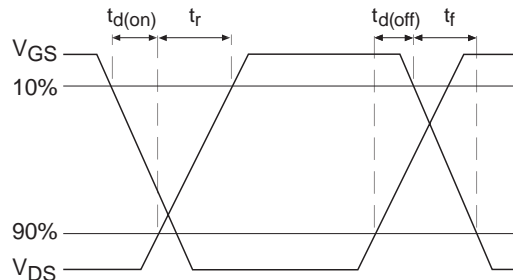
**Fig 17a. Unclamped Inductive Test Circuit**



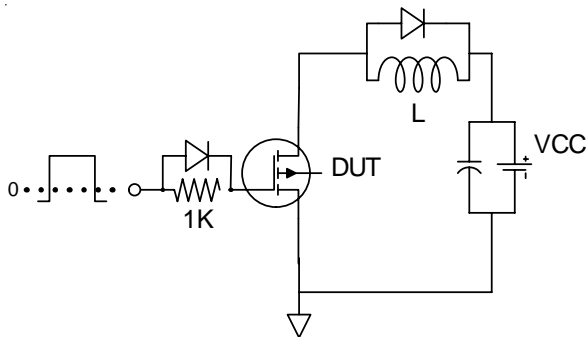
**Fig 17b. Unclamped Inductive Waveforms**



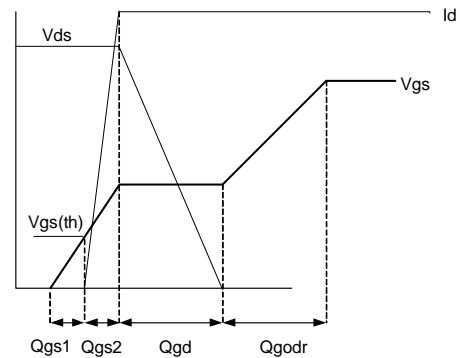
**Fig 18a. Switching Time Test Circuit**



**Fig 18b. Switching Time Waveforms**



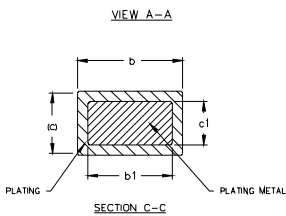
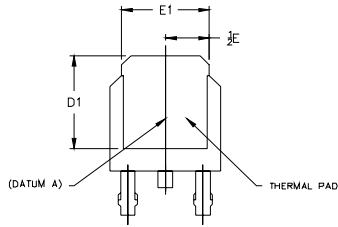
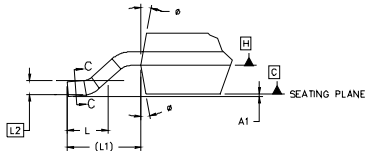
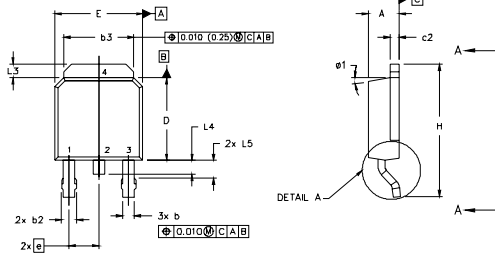
**Fig 19a. Gate Charge Test Circuit**



**Fig 19b Gate Charge Waveform**

## D-Pak (TO-252AA) Package Outline

Dimensions are shown in millimeters (inches)



**NOTES:**

- 1.0 DIMENSIONING AND TOLERANCING PER ASME Y14.5 M- 1994.
- 2.0 DIMENSIONS ARE SHOWN IN INCHES [MILLIMETERS].
- 3.0 LEAD DIMENSION UNCONTROLLED IN L5
- 4.0 DIMENSION D1 AND E1 ESTABLISH A MINIMUM MOUNTING SURFACE FOR THERMAL PAD.
- 5.0 SECTION C-C DIMENSIONS APPLY TO THE FLAT SECTION OF THE LEAD BETWEEN .005 [0.127] AND .010 [0.254] FROM THE LEAD TIP.
- 6.0 DIMENSION D & E DO NOT INCLUDE MOLD FLASH. MOLD FLASH SHALL NOT EXCEED .005" (0.127) PER SIDE. THESE DIMENSIONS ARE MEASURED AT THE OUTERMOST EXTREMES OF THE PLASTIC BODY.
- 7.0 OUTLINE CONFORMS TO JEDEC OUTLINE TO-252AA.

SYMBOL	DIMENSIONS				NOTES
	MILLIMETERS		INCHES		
	MIN.	MAX.	MIN.	MAX.	
A	2.18	2.39	.086	.094	
A1		0.13		.005	
b	0.64	0.89	.025	.035	5
b1	0.64	0.79	.025	0.031	5
b2	0.76	1.14	.030	.045	
b3	4.95	5.46	.195	.215	
c	0.46	0.61	.018	.024	5
c1	0.41	0.56	.016	.022	5
c2	.046	0.89	.018	.035	5
D	5.97	6.22	.235	.245	6
D1	5.21	-	.205	-	4
E	6.35	6.73	.250	.265	6
E1	4.32	-	.170	-	4
e	2.29		.090 BSC		
H	9.40	10.41	.370	.410	
L	1.40	1.78	.055	.070	
L1	2.74 REF.		.108 REF.		
L2	0.051 BSC		.020 BSC		
L3	0.89	1.27	.035	.050	
L4		1.02		.040	
L5	1.14	1.52	.045	.060	3
φ	0"	10"	0"	10"	
φ1	0"	15"	0"	15"	

LEAD ASSIGNMENTS

HEXFET

- 1.- GATE
- 2.- DRAIN
- 3.- SOURCE
- 4.- DRAIN

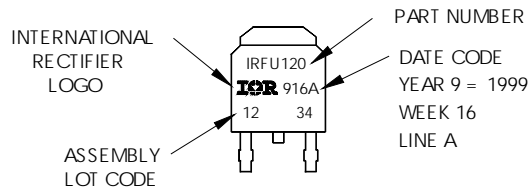
IGBTs, CoPACK

- 1.- GATE
- 2.- COLLECTOR
- 3.- EMITTER
- 4.- COLLECTOR

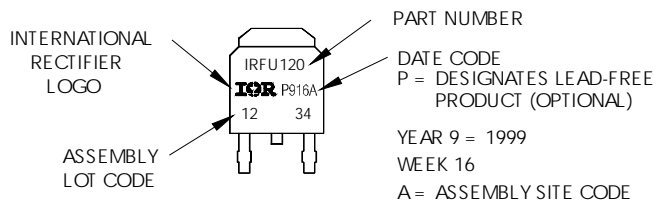
## D-Pak (TO-252AA) Part Marking Information

EXAMPLE: THIS IS AN IRLFR120  
WITH ASSEMBLY  
LOT CODE 1234  
ASSEMBLED ON WW 16, 1999  
IN THE ASSEMBLY LINE "A"

Note: "P" in assembly line position  
indicates "Lead-Free"

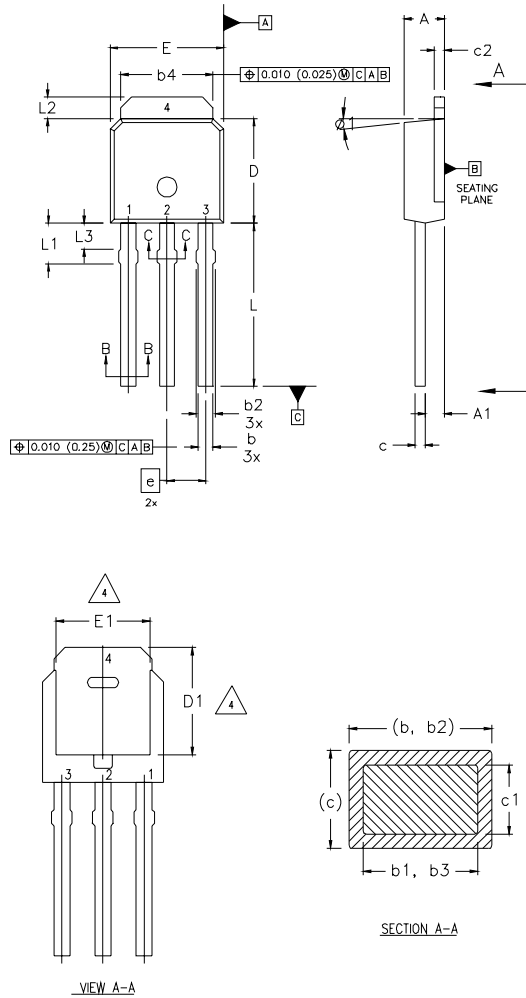


OR



## I-Pak (TO-251AA) Package Outline

Dimensions are shown in millimeters (inches)



NOTES:

- 1 DIMENSIONING AND TOLERANCING PER ASME Y14.5 M- 1994.
- 2 DIMENSIONS ARE SHOWN IN MILLIMETERS [INCHES].
- 3 DIMENSION D & E DO NOT INCLUDE MOLD FLASH. MOLD FLASH SHALL NOT EXCEED 0.005" (0.127) PER SIDE. THESE DIMENSIONS ARE MEASURED AT THE OUTERMOST EXTREMES OF THE PLASTIC BODY.
- 4 THERMAL PAD CONTOUR OPTION WITHIN DIMENSION b4, L2, E1 & D1.
- 5 LEAD DIMENSION UNCONTROLLED IN L3.
- 6 DIMENSION b1, b3 APPLY TO BASE METAL ONLY.
- 7 OUTLINE CONFORMS TO JEDEC OUTLINE TO-251AA.
- 8 CONTROLLING DIMENSION : INCHES.

LEAD ASSIGNMENTS

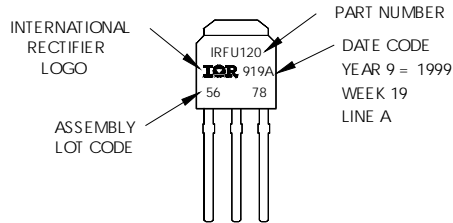
HEXFET

- 1.- GATE
- 2.- DRAIN
- 3.- SOURCE
- 4.- DRAIN

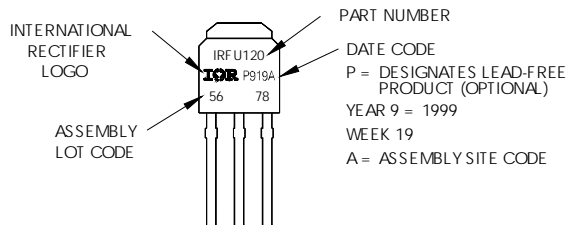
SYMBOL	DIMENSIONS				NOTES
	MILLIMETERS		INCHES		
	MIN.	MAX.	MIN.	MAX.	
A	2.18	2.39	0.086	.094	
A1	0.89	1.14	0.035	0.045	
b	0.64	0.89	0.025	0.035	
b1	0.64	0.79	0.025	0.031	4
b2	0.76	1.14	0.030	0.045	
b3	0.76	1.04	0.030	0.041	
b4	5.00	5.46	0.195	0.215	4
c	0.46	0.61	0.018	0.024	
c1	0.41	0.56	0.016	0.022	
c2	.046	0.86	0.018	0.035	
D	5.97	6.22	0.235	0.245	3, 4
D1	5.21	-	0.205	-	4
E	6.35	6.73	0.250	0.265	3, 4
E1	4.32	-	0.170	-	4
e	2.29		0.090 BSC		
L	8.89	9.60	0.350	0.380	
L1	1.91	2.29	0.075	0.090	
L2	0.89	1.27	0.035	0.050	4
L3	1.14	1.52	0.045	0.060	5
ø1	Ø	15'	Ø	15'	

## I-Pak (TO-251AA) Part Marking Information

EXAMPLE: THIS IS AN IRFU120  
WITH ASSEMBLY  
LOT CODE 5678  
ASSEMBLED ON WW 19, 1999  
IN THE ASSEMBLY LINE "A"  
**Note:** "P" in assembly line  
position indicates "Lead-Free"



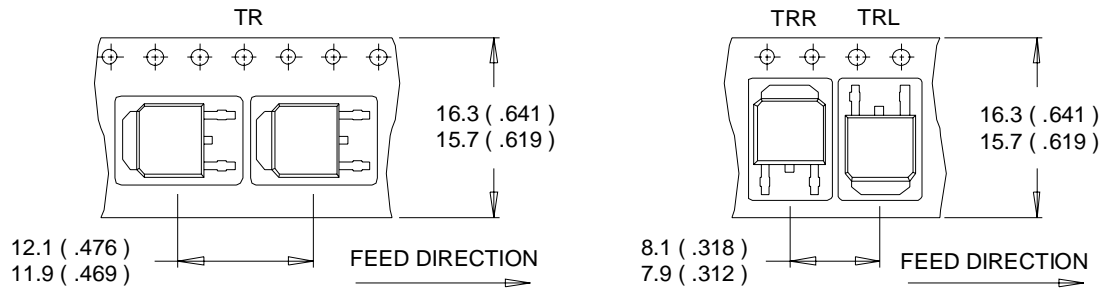
OR





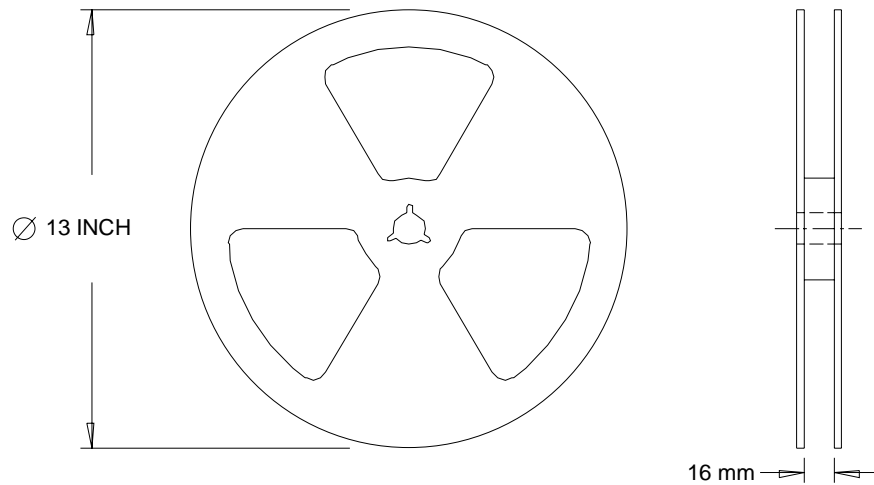
## D-Pak (TO-252AA) Tape & Reel Information

Dimensions are shown in millimeters (inches)



**NOTES :**

1. CONTROLLING DIMENSION : MILLIMETER.
2. ALL DIMENSIONS ARE SHOWN IN MILLIMETERS ( INCHES ).
3. OUTLINE CONFORMS TO EIA-481 & EIA-541.



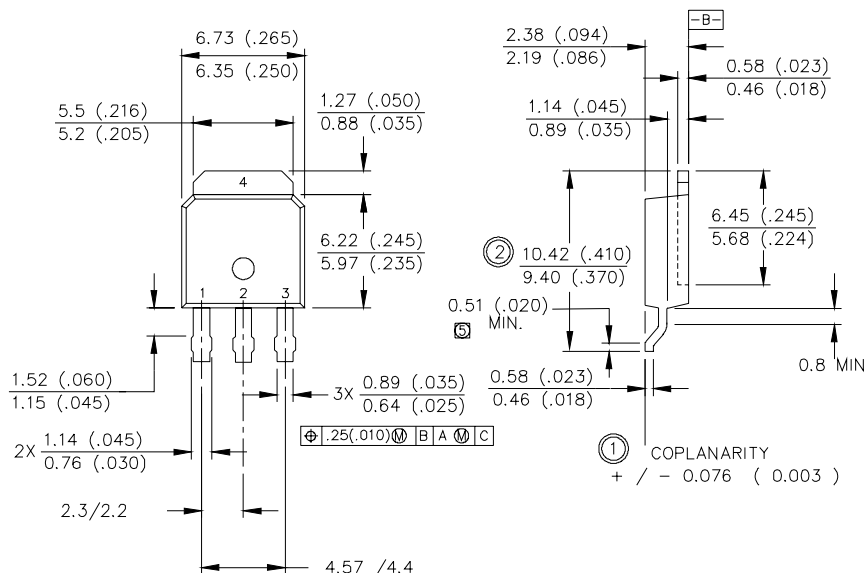
**NOTES :**

1. OUTLINE CONFORMS TO EIA-481.

# IRLR/U9343PbF & IRLU9343-701PbF

## I-Pak Leadform Option 701 Package Outline ⑨

Dimensions are shown in millimeters (inches)



- 1-. GATE
- 2-. DRAIN
- 3-. SOURCE
- 4-. DRAIN

### NOTES:

- 1.0 CONTROL DIMENSIONS IN INCHES
- 2.0 PARALLELISM AND ANGULARITY MAX. 0.076 (0.003)
- 3.0 LEADFORM CRITICAL DIMENSIONS DOUBLE RINGED

### Notes:

- ① Repetitive rating; pulse width limited by max. junction temperature.
- ② Starting  $T_J = 25^\circ\text{C}$ ,  $L = 1.24\text{mH}$ ,  $R_G = 25\Omega$ ,  $I_{AS} = -14\text{A}$ .
- ③ Pulse width  $\leq 400\mu\text{s}$ ; duty cycle  $\leq 2\%$ .
- ④ This only applies for I-Pak,  $L_S$  of D-Pak is measured between lead and center of die contact
- ⑤  $R_\theta$  is measured at  $T_J$  of approximately  $90^\circ\text{C}$ .
- ⑥ Contact factory for mounting information
- ⑦ Limited by  $T_{jmax}$ . See Figs. 14, 15, 17a, 17b for repetitive avalanche information
- ⑧ When D-Pak mounted on 1" square PCB (FR-4 or G-10 Material) . For recommended footprint and soldering techniques refer to application note #AN-994
- ⑨ Refer to D-Pak package for Part Marking, Tape and Reel information.

Data and specifications subject to change without notice.  
This product has been designed for the Industrial market.  
Qualification Standards can be found on IR's Web site.

Note: For the most current drawings please refer to the IR website at:  
<http://www.irf.com/package/>