

LMP91050

Configurable AFE for Nondispersive Infrared (NDIR) Sensing Applications

General Description

The LMP91050 is a programmable integrated Sensor Analog Front End (AFE) optimized for thermopile sensors, as typically used in NDIR applications. It provides a complete signal path solution between a sensor and microcontroller that generates an output voltage proportional to the thermopile voltage. The LMP91050's programmability enables it to support multiple thermopile sensors with a single design as opposed to the multiple discrete solutions.

The LMP91050 features a programmable gain amplifier (PGA), "dark phase" offset cancellation, and an adjustable common mode generator (1.15V or 2.59V) which increases output dynamic range. The PGA offers a low gain range of 167V/V to 1335V/V plus a high gain range of 1002V/V to 7986V/V which enables the user to utilize thermopiles with different sensitivities. The PGA is highlighted by low gain drift (100 ppm/°C), output offset drift (1.2mV/°C at G = 1002 V/V), phase delay drift (500ns) and noise specifications (0.1 μV_{RMS} 0.1 to 10Hz). The offset cancellation circuitry compensates for the "dark signal" by adding an equal and opposite offset to the input of the second stage, thus removing the original offset from the output signal. This offset cancellation circuitry allows optimized usage of the ADC full scale and relaxes ADC resolution requirements.

The LMP91050 allows extra signal filtering (high pass, low pass or band pass) through dedicated pins A0 and A1, in order to remove out of band noise. The user can program through the on board SPI interface. Available in a small form factor 10-pin MSOP package, the LMP91050 operates from -40 to +105°C.

Key Specifications

■ Programmable gain	167V/V to 7986V/V
■ Low noise (0.1 to 10 Hz)	0.1 μV_{RMS}
■ Gain Drift	100 ppm/°C (max)
■ Phase Delay Drift	500ns (max)
■ Power supply voltage range	2.7V to 5.5V

Features

- Programmable gain amplifier
- "Dark Signal" offset cancellation
- Supports external filtering
- Common mode generator and 8 bit DAC
- 10 pin MSOP package

Applications

- NDIR sensing
- Demand control ventilation
- Building monitoring
- CO2 cabin control — Automotive
- Alcohol detection — Automotive
- Industrial safety and security
- GHG & Freons detection platforms

Block Diagram

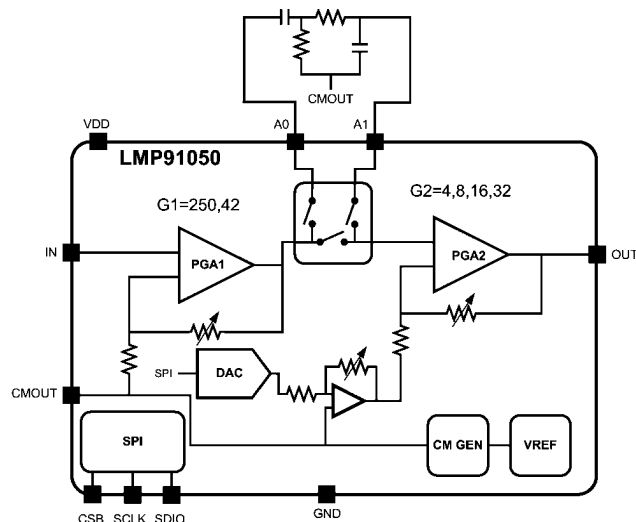

Configurable AFE for NDIR

30164108

Typical Application

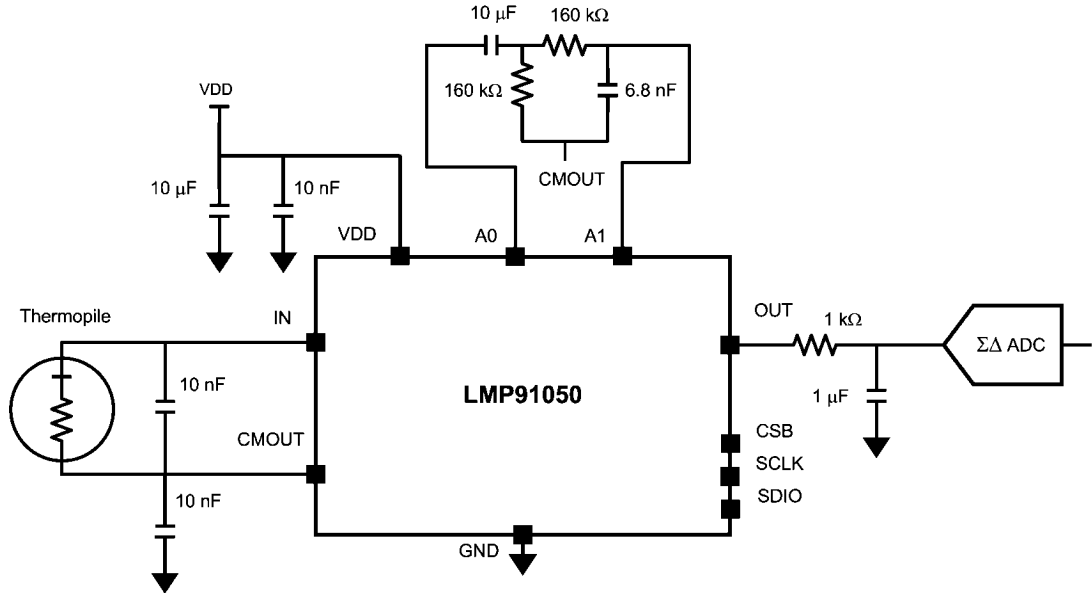

Typical NDIR Sensing Application Circuit

30164111

Ordering Information

Package	Part Number	Package Marking	Transport Media	NSC Drawing
10-Pin MSOP	LMP91050MM	AN8A	1K units tape and reel	MUB10A
	LMP91050MME		250 units tape and reel	
	LMP91050MMX		3.5K units tape and reel	

Connection Diagram

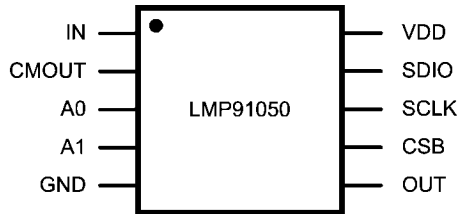

30164106

Pin Descriptions

Pin	Symbol	Type	Description
1	IN	Analog Input	Signal Input
2	CMOUT	Analog Output	Common Mode Voltage Output
3	A0	Analog Output	First Stage Output
4	A1	Analog Input	Second Stage Input
5	GND	Power	Ground
6	OUT	Analog Output	Signal Output, reference to the same potential as CMOUT
7	CSB	Digital Input	Chip Select, active low
8	SCLK	Digital Input	Interface Clock
9	SDIO	Digital Input / Output	Serial Data Input / Output
10	VDD	Power	Positive Supply

Absolute Maximum Ratings (Note 1)

If Military/Aerospace specified devices are required, please contact the Texas Instruments Sales Office/Distributors for availability and specifications.

ESD Tolerance (Note 2)

Human Body Model	2500V
Machine Model	250V
Charged Device Model	1250V
Supply Voltage (VDD)	-0.3V to 6.0V
Voltage at Any Pin	- 0.3V to VDD + 0.3V
Input Current at Any Pin	5mA
Storage Temperature Range	-65°C to 150°C
Junction Temperature (Note 3)	150°C

For soldering specifications:

see product folder at www.national.com and
www.national.com/ms/MS/MS-SOLDERING.pdf

Operating Ratings (Note 1)

Supply Voltage	2.7V to 5.5V
Junction Temperature Range (Note 3)	-40°C to 105°C
Package Thermal Resistance, θ_{JA} 10 Lead MSOP	176 °C/W

Electrical Characteristics (Note 4) The following specifications apply for VDD = 3.3V, VCM = 1.15V, **Bold** values for $T_A = -40^\circ\text{C}$ to $+85^\circ\text{C}$ unless otherwise specified. All other limits apply to $T_A = T_J = +25^\circ\text{C}$.

Symbol	Parameter	Conditions	Min (Note 6)	Typ (Note 5)	Max (Note 6)	Units
Power Supply						
VDD	Supply Voltage		2.7	3.3	5.5	V
IDD	Supply Current	All analog block ON	3.1	3.7	4.2	mA
	Power Down Supply Current	All analog block OFF	45	85	121	μA
Offset Cancellation (Offset DAC)						
	Resolution			256		steps
	LSB	All gains		33.8		mV
	DNL		-1		2	LSB
	Error	Output referred offset error, all gains		± 100		mV
	Offset adjust Range	Output referred, all gains	0.2		VDD - 0.2	V
	DAC settling time			480		μs
Programmable Gain Amplifier (PGA) 1st Stage, $R_L = 10\text{k}\Omega$, $C_L = 15\text{pF}$						
IBIAS	Bias Current			5	200	pA
VINMAX_HGM	Max input signal High gain mode	Referenced to CMOUT voltage, it refers to the maximum voltage at the IN pin before clipping; It includes dark voltage of the thermopile and signal voltage.		± 2		mV
VINMAX_LGM	Max input signal Low gain mode			± 12		mV
VOS	Input Offset Voltage			-165		μV
G_HGM	Gain High gain mode			250		V/V
G_LGM	Gain Low gain mode			42		V/V
GE	Gain Error	Both HGM and LGM		2.5		%
VOUT	Output Voltage Range		0.5		VDD - 0.5	V
PhDly	Phase Delay	1mV input step signal, HGM, Vout measured at Vdd/2		6		μs
TCPHDly	Phase Delay variation with Temperature	1mV input step signal, HGM, Vout measured at Vdd/2,		416		ns
SSBW	Small Signal Bandwidth	Vin = 1mVpp, Gain = 250 V/V		18		kHz
Cin	Input Capacitance			100		pF
Programmable Gain Amplifier (PGA) 2nd Stage, $R_S = 1\text{k}\Omega$, $C_L = 1\mu\text{F}$						

Symbol	Parameter	Conditions	Min (Note 6)	Typ (Note 5)	Max (Note 6)	Units
VINMAX	Max input signal	GAIN = 4 V/V		1.65		V
VINMIN	Min input signal			0.82		V
G	Gain	Programmable in 4 steps	4		32	V/V
GE	Gain Error	Any gain		2.5		%
VOUT	Output Voltage Range		0.2		VDD – 0.2	V
PhDly	Phase Delay	100mV input sine 35kHz signal, Gain = 8, VO _{UT} measured at 1.65V, R _L = 10kΩ		1		μs
TCPHDly	Phase Delay variation with Temperature	250mV input step signal, Gain = 8, V _{out} measured at V _{DD} /2		84		ns
SSBW	Small Signal Bandwidth	Gain = 32 V/V		360		kHz
C _{in}	Input Capacitance			5		pF
C _{LOAD, OUT}	OUT Pin Load Capacitance	Series RC		1		μF
R _{LOAD, OUT}	OUT Pin Load Resistance	Series RC		1		kΩ
Combined Amplifier Chain Specification						
e _n	Input-Referred Noise Density	Combination of both current and voltage noise, with a 86kΩ source impedance at 5Hz, Gain = 7986		30		nV/√Hz
	Input-Referred Integrated Noise	Combination of both current and voltage noise, with a 86kΩ source impedance 0.1Hz to 10Hz, Gain = 7986		0.1	0.12 (Note 9)	μVrms
G	Gain	PGA1 GAIN = 42, PGA2 GAIN = 4		167		V/V
		PGA1 GAIN = 42, PGA2 GAIN = 8		335		
		PGA1 GAIN = 42, PGA2 GAIN = 16		669		
		PGA1 GAIN = 42, PGA2 GAIN = 32		1335		
		PGA1 GAIN = 250, PGA2 GAIN = 4		1002		
		PGA1 GAIN = 250, PGA2 GAIN = 8		2004		
		PGA1 GAIN = 250, PGA2 GAIN = 16		4003		
		PGA1 GAIN = 250, PGA2 GAIN = 32		7986		
GE	Gain Error	Any gain		5		%
TCCGE	Gain Temp Coefficient (Note 7)				100	ppm/°C
PSRR	Power Supply Rejection Ratio	DC, 3.0V to 3.6V supply, gain = 1002V/V	90	110		dB
PhDly	Phase Delay	1mV input step signal, Gain = 1002, V _{out} measured at V _{DD} /2		9		μs
TCPHDly	Phase Delay variation with Temperature (Note 8)	1mV input step signal, Gain=1002, V _{out} measured at V _{DD} /2			500	ns
TCVOS	Output Offset Voltage Temperature Drift (Note 7)	Gain = 167 V/V	-0.525		0.525	mV/°C
		Gain = 335 V/V	-0.60		0.60	
		Gain = 669 V/V	-0.90		0.90	
		Gain = 1335 V/V	-1.50		1.50	
		Gain = 1002 V/V	-1.20		1.20	
		Gain = 2004 V/V	-1.90		1.90	
		Gain = 4003 V/V	-3.70		3.70	
		Gain = 7986V/V	-7.10		7.10	
Common Mode Generator						
VCM	Common Mode Voltage	Programmable, see Common Mode Generation		1.15 or 2.59		V

Symbol	Parameter	Conditions	Min (Note 6)	Typ (Note 5)	Max (Note 6)	Units
	VCM accuracy			2		%
CLOAD	CMOut Load Capacitance			10		nF

SPI Interface (Note 4) The following specifications apply for VDD = 3.3V, VCM = 1.15V, C_L = 15pF, **Bold** values for T_A = -40°C to +85°C unless otherwise specified. All other limits apply to T_A = T_J = +25°C.

Symbol	Parameter	Conditions	Min (Note 6)	Typ (Note 5)	Max (Note 6)	Units
V _{IH}	Logic Input High		0.7 × VDD			V
V _{IL}	Logic Input Low				0.8	V
V _{OH}	Logic Output High		2.6			V
V _{OL}	Logic Output Low				0.4	V
I _{IH} /I _{IL}	Input Digital Leakage Current		-100 -200		100 200	nA

Timing Characteristics (Note 4) The following specifications apply for VDD = 3.3V, VCM = 1.15V, C_L = 15pF, **Bold** values for T_A = -40°C to +85°C unless otherwise specified. All other limits apply to T_A = T_J = +25°C.

Symbol	Parameter	Conditions	Min (Note 6)	Typ (Note 5)	Max (Note 6)	Units
t _{WU}	Wake up time			1		ms
f _{SCLK}	Serial Clock Frequency				10	MHz
t _{PH}	SCLK Pulse Width High		0.4/f _{SCLK}			ns
t _{PL}	SCLK Pulse Width Low		0.4/f _{SCLK}			ns
t _{CSS}	CSB Setup Time		10			ns
t _{CSH}	CSB Hold Time		10			ns
t _{SU}	SDI Setup Time prior to rise edge of SCLK		10			ns
t _{SH}	SDI Hold Time prior to rise edge of SCLK		10			ns
t _{DOD1}	SDO Disable Time after rise edge of CSB				45	ns
t _{DOD2}	SDO Disable Time after 16 th rise edge of SCLK				45	ns
t _{DOE}	SDO Enable Time from the fall edge of 8 th SCLK				35	ns
t _{DOA}	SDO Access Time after the fall edge of SCLK				35	ns
t _{DOH}	SDO hold time after the fall edge of SCLK		5			ns
t _{DOR}	SDO Rise time			5		ns
t _{DOF}	SDO Fall time			5		ns

Note 1: "Absolute Maximum Ratings" indicate limits beyond which damage to the device may occur, including inoperability and degradation of device reliability and/or performance. Functional operation of the device and/or non-degradation at the Absolute Maximum Ratings or other conditions beyond those indicated in the Operating Ratings is not implied. Operating Ratings indicate conditions at which the device is functional and the device should not be operated beyond such conditions.

Note 2: Human Body Model, applicable std. MIL-STD-883, Method 3015.7. Machine Model, applicable std. JESD22-A115-A (ESD MM std. of JEDEC) Field-Induced Charge-Device Model, applicable std. JESD22-C101-C (ESD FICDM std. of JEDEC).

Note 3: The maximum power dissipation is a function of $T_{J(MAX)}$, θ_{JA} , and the ambient temperature, T_A . The maximum allowable power dissipation at any ambient temperature is $P_{D(MAX)} = (T_{J(MAX)} - T_A) / \theta_{JA}$. All numbers apply for packages soldered directly onto a PC board.

Note 4: Electrical Table values apply only for factory testing conditions at the temperature indicated. Factory testing conditions result in very limited self-heating of the device such that $T_J = T_A$. No guarantee of parametric performance is indicated in the electrical tables under conditions of internal self-heating where $T_J > T_A$. Absolute Maximum Ratings indicate junction temperature limits beyond which the device may be permanently degraded, either mechanically or electrically.

Note 5: Typical values represent the most likely parametric norm as determined at the time of characterization. Actual typical values may vary over time and will also depend on the application and configuration. The typical values are not tested and are not guaranteed on shipped production material.

Note 6: Limits are 100% production tested at 25°C. Limits over the operating temperature range are guaranteed through correlations using statistical quality control (SQC) method.

Note 7: TCCGE and TCVOs are calculated by taking the largest slope between -40°C and 25°C linear interpolation and 25°C and 85°C linear interpolation.

Note 8: TCPhDly is largest change in phase delay between -40°C and 25°C measurements and 25°C and 85°C measurements.

Note 9: Guaranteed by design and characterization. Not tested on shipped production material.

Timing Diagrams

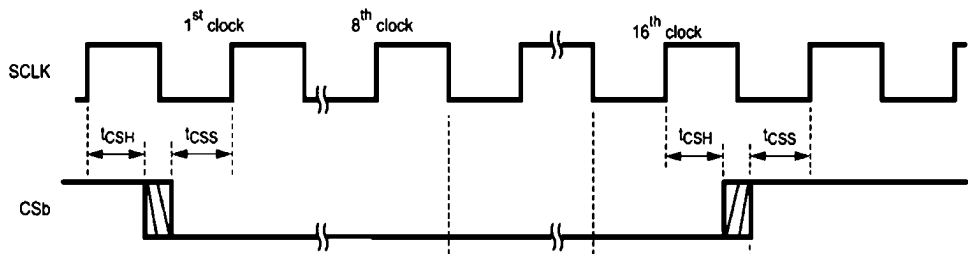

30164112

FIGURE 1. SPI Timing Diagram

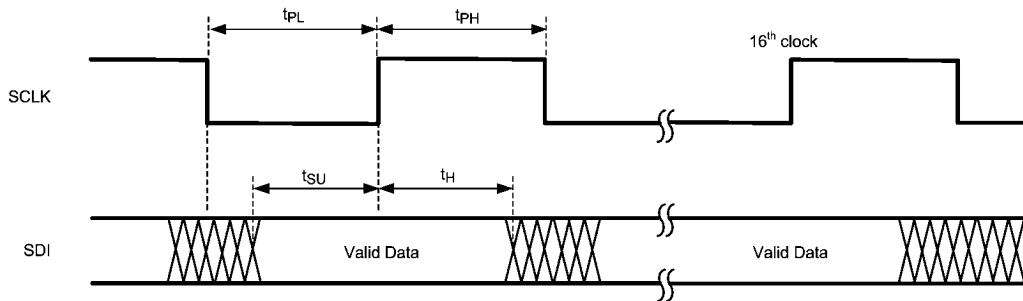

30164113

FIGURE 2. SPI Set-up Hold Time

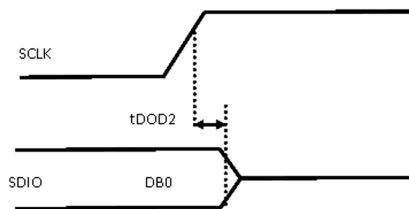

30164117

FIGURE 3. SDO disable time after 16th rise edge of SCLK

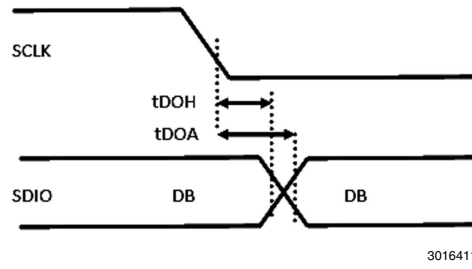

30164116

FIGURE 4. SDO access time (t_{DOA}) and SDO hold time (t_{DOH}) after the fall edge of SCLK

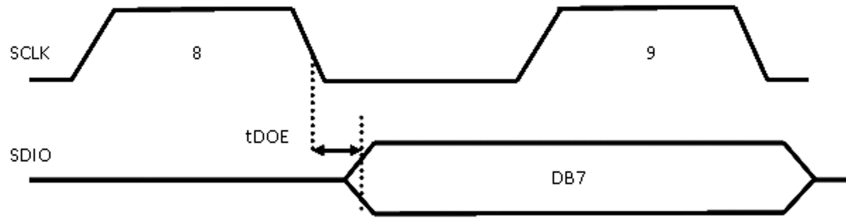

30164118

FIGURE 5. SDO Enable time from the fall of 8th SCLK

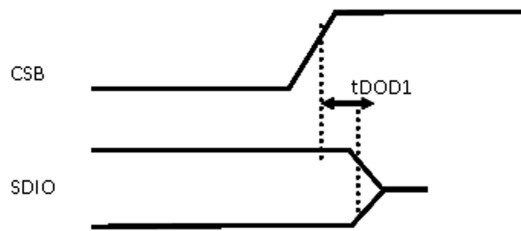

30164119

FIGURE 6. SDO disable time after rise edge of CSB

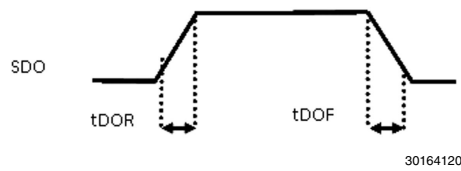

30164120

FIGURE 7. SDO rise and fall times

Typical Performance Characteristics

VDD = +3.3V, VCM = 1.15V, and T_A = 25°C unless otherwise noted

noted

Gain = 167 V/V vs. Temperature

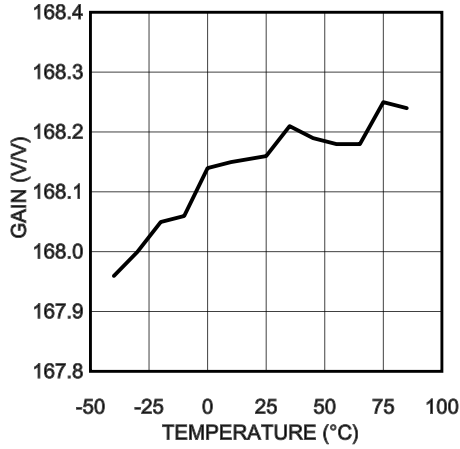

30164125

Gain = 335 V/V vs. Temperature

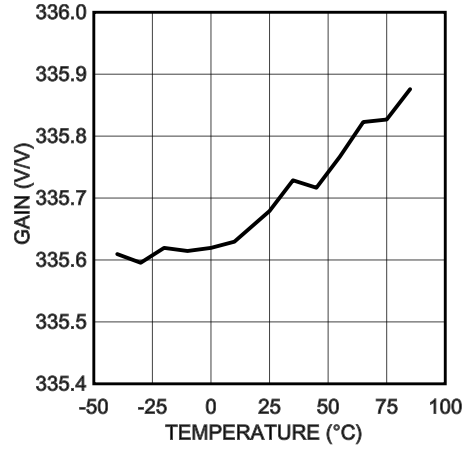

30164124

Gain = 669 V/V vs. Temperature

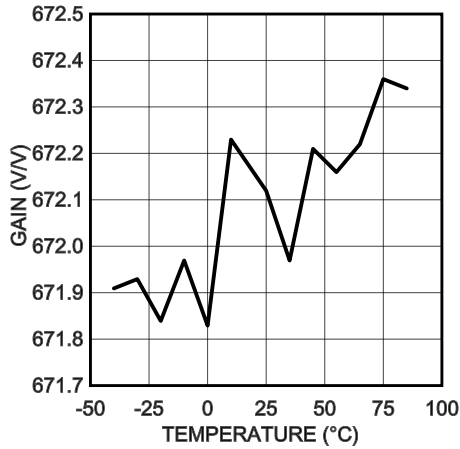

30164123

Gain = 1002 V/V vs. Temperature

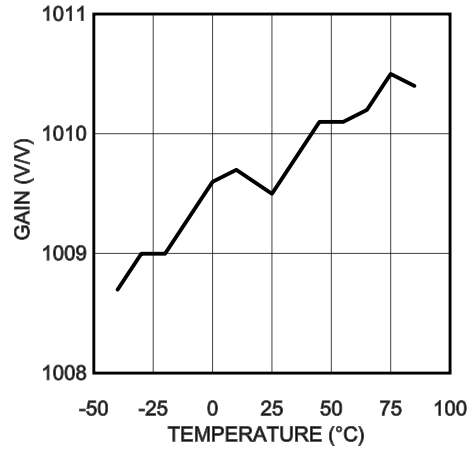

30164127

Gain = 2004 V/V vs. Temperature

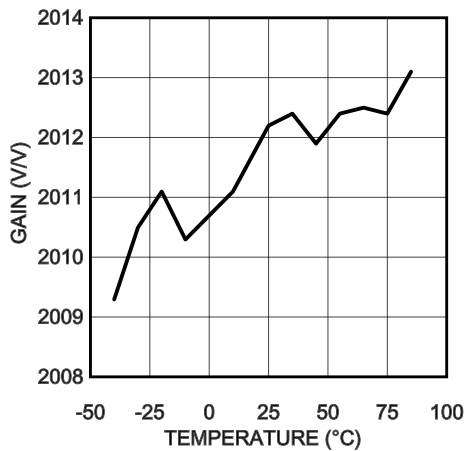

30164126

Phase Delay vs. Temperature

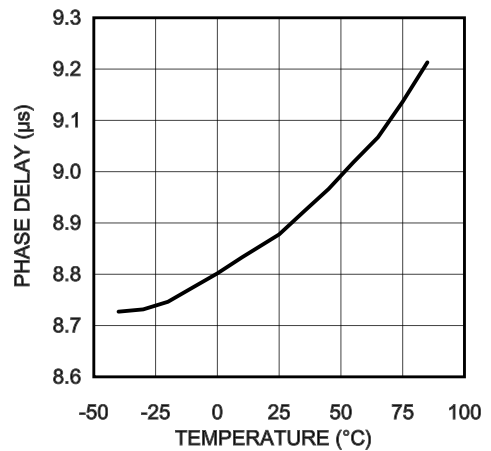

30164122

Output Offset vs. Temperature

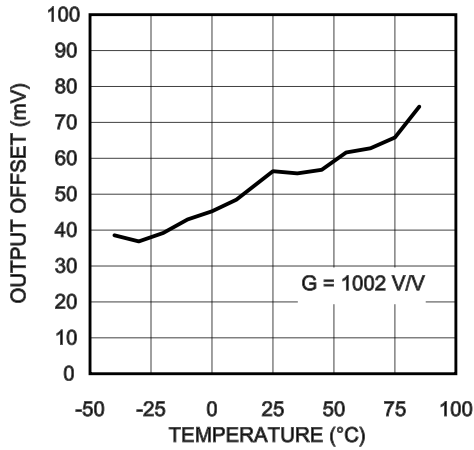

30164128

Common Mode Voltage vs. Temperature

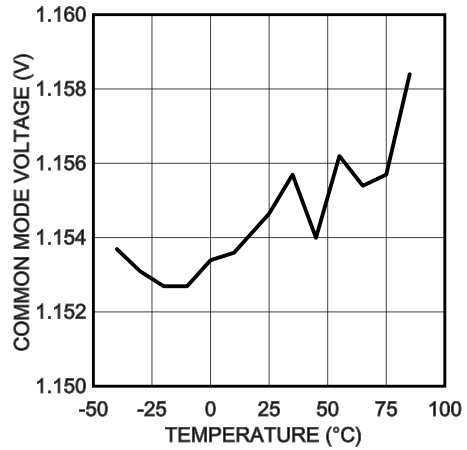

301641100

Input Bias Current vs. Temperature

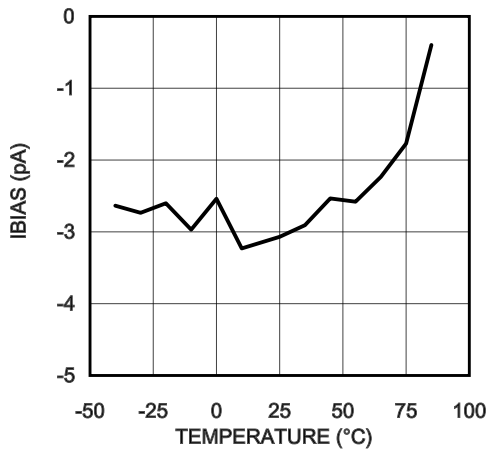

30164143

Supply Current vs. Temperature

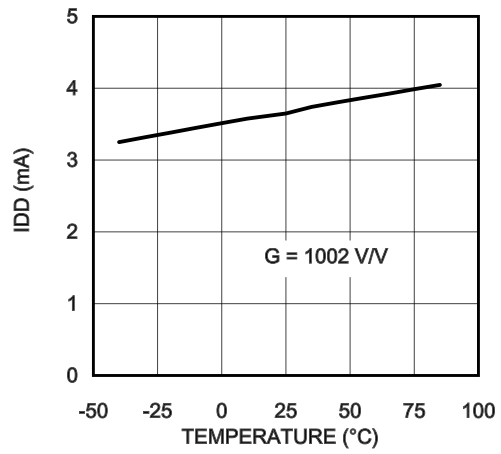

30164142

Supply Current vs. Supply Voltage

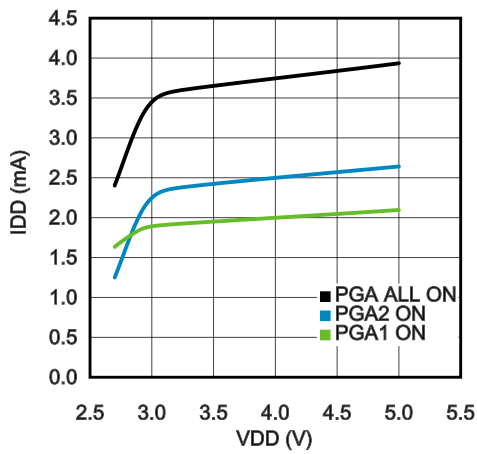

30164131

Power Down Supply Current vs. Supply Voltage

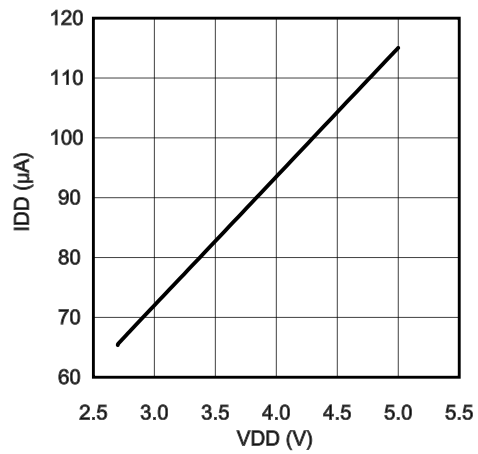

30164130

Output Offset vs. Supply Voltage

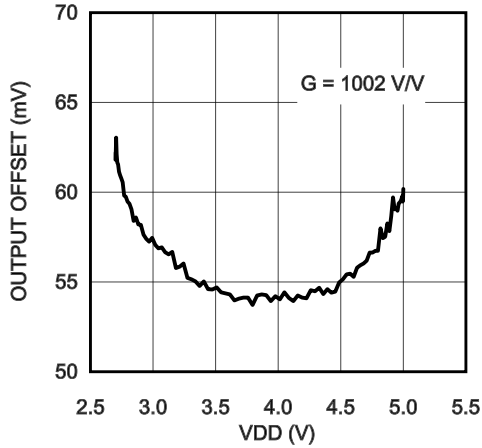

30164129

PGA1 Small Signal Bandwidth

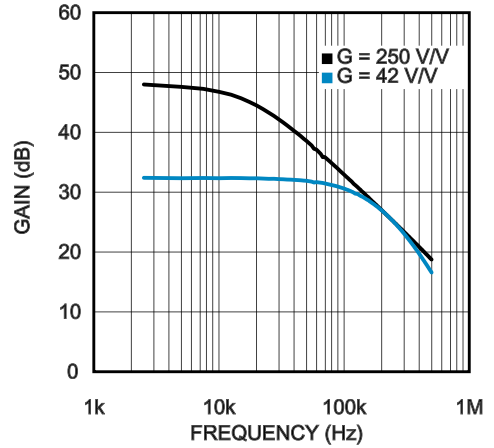

30164133

PGA2 Small Signal Bandwidth

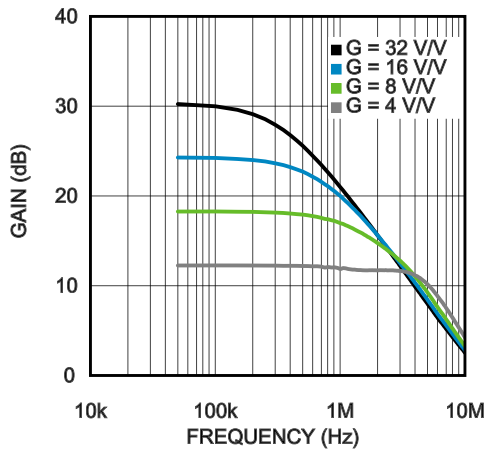

30164132

Power Supply Rejection Ratio vs. Frequency

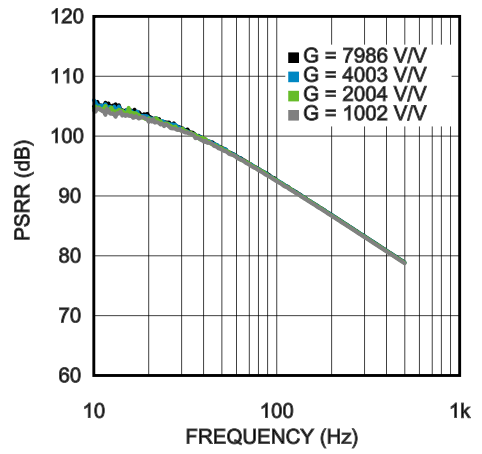

30164134

Input-Referred Noise Density vs. Frequency

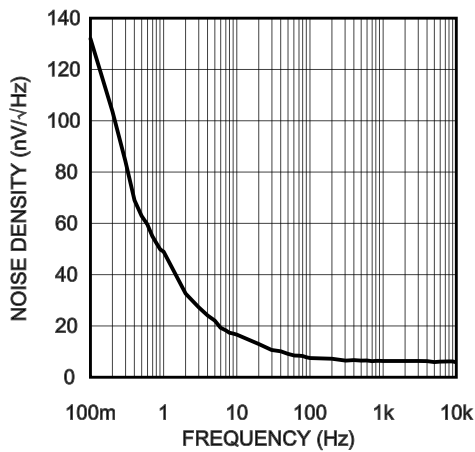

30164145

DAC DC Sweep

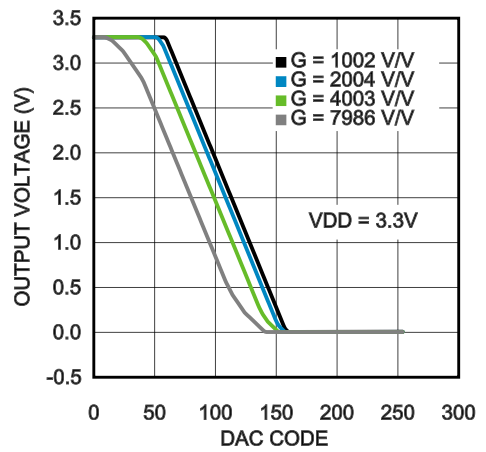

30164139

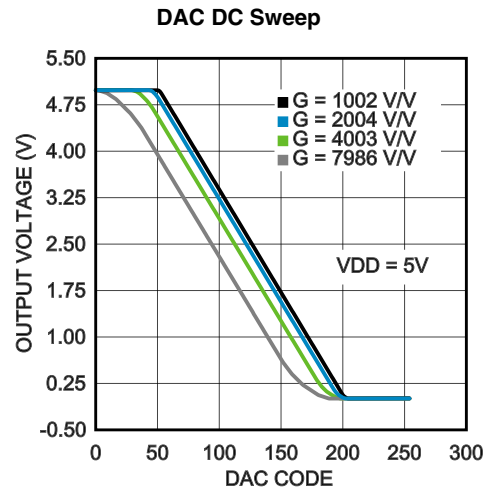

30164140

Functional Description

PROGRAMMABLE GAIN AMPLIFIER

The LMP91050 offers two programmable gain modes (low/high) with four programmable gain settings each. The purpose of the gain mode is to enable thermopiles with larger dark voltage levels. All gain settings are accessible through bits GAIN1 and GAIN2[1:0]. The low gain mode has a range

of 167 V/V to 1335 V/V while the high gain mode has a range of 1002 V/V to 7986 V/V. The PGA is referenced to the internally generated VCM. Input signal, referenced to this VCM voltage, should be within +/-2mV (see VINMAX_HGM specification) in high gain mode. In the low gain mode the first stage will provide a gain of 42 V/V instead of 250 V/V, thus allowing a larger maximum input signal up to +/-12mV (VINMAX_LGM).

TABLE 1. Gain Modes

Bit Symbol	Gain
GAIN1	0: 250 (default)
	1: 42
GAIN2 [1:0]	00: 4 (default)
	01: 8
	10: 16
	11: 32

EXTERNAL FILTER

The LMP91050 offers two different measurement modes selectable through EXT_FILT bit. EXT_FILT bit is present in the

Device configuration register and is programmable through SPI.

TABLE 2. Measurement Modes

Bit Symbol	Measurement Mode
EXT_FILT	0: The signal from the thermopile is being processed by the internal PGAs, without additional external decoupling or filtering (default).
	1: The signal from the thermopile is being processed by the first internal PGA and fed to the A0 pin. An external low pass, high pass or band pass filter can be connected through pins A0, A1.

An external filter can be applied when EXT_FILT = 1. A typical band pass filter is shown in the picture below. Resistor and capacitor can be connected to the CMOUT pin of the

LMP91050 as shown. Discrete component values have been added for reference.

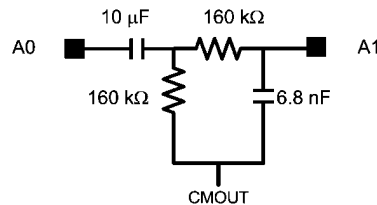

30164107

FIGURE 8. Typical Bandpass Filter

OFFSET ADJUST

Procedure of the offset adjust is to first measure the “dark signal”, program the DAC to adjust, and then measure in a second cycle the residual of the dark signal for further signal manipulation within the µC. The signal source is expected to have an offset component (dark signal) larger than the actual signal. During the “dark phase”, the time when no light is de-

ected by the sensor, the µC can program LMP91050 internal DAC to compensate for a measured offset. A low output offset voltage temperature drift (TCVOS) ensures system accuracy over temperature. See [Figure 9](#) below which plots the maximum TCVOS allowed over a given temperature drift in order to achieve n bit system accuracy.

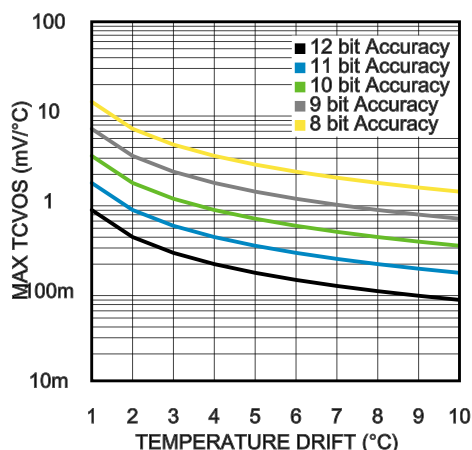

30164144

FIGURE 9. System Accuracy vs. TC沃斯 and Temperature Drift

COMMON MODE GENERATION

As the sensor's offset is bipolar, there is a need to supply a VCM to the sensor. This can be programmed as 1.15V or 2.59V (approximately mid rail of 3.3V or 5V supply). It is not recommended to use 2.59V VCM with 3.3V supply

SPI INTERFACE

An SPI interface is available in order to program the device parameters like PGA gain of two stages, enabling external filter, enabling power for PGAs, offset adjust and common mode (VCM) voltage.

Interface Pins

The Serial Interface consists of SDIO (Serial Data Input / Output), SCLK (Serial Interface Clock) and CSB (Chip Select Bar). The serial interface is write-only by default. Read operations are supported after unlocking the SDIO_MODE_PASSWD. This is discussed in detail later in the document.

CSB

Chip Select is a active-low signal. CSB needs to be asserted throughout a transaction. That is, CSB should not pulse be-

tween the Instruction Byte and the Data Byte of a single transaction.

Note that CSB de-assertion always terminates an on-going transaction, if it is not already complete. Likewise, CSB assertion will always bring the device into a state, ready for next transaction, regardless of the termination status of a previous transaction.

CSB may be permanently tied low for a 2-wire SPI communication protocol.

SCLK

SCLK can idle High or Low for a write transaction. However, for a READ transaction, SCLK should idle high. SCLK features a Schmitt-triggered input and although it has hysteresis, it is recommended to keep SCLK as clean as possible to prevent glitches from inadvertently spoiling the SPI frame.

Communication Protocol

Communication on the SPI normally involves Write and Read transactions. Write transaction consists of single Write Command Byte, followed by single Data byte. The following figure shows the SPI Interface Protocol for write transaction.

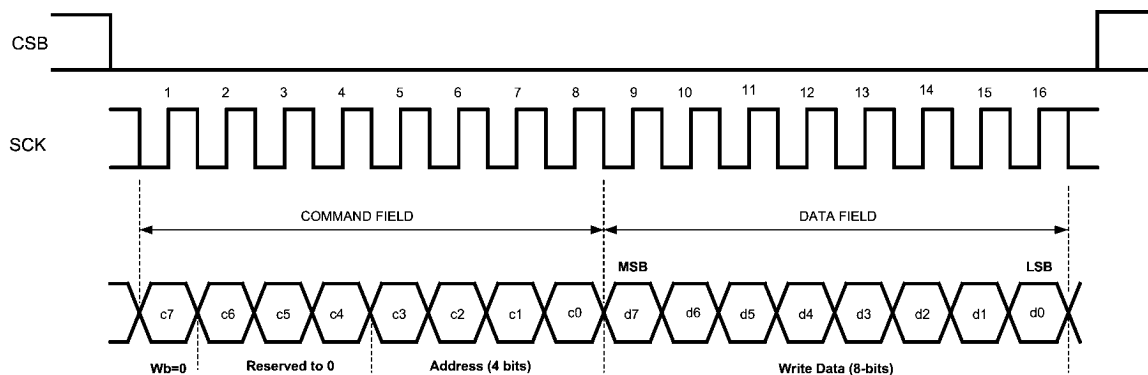

30164109

FIGURE 10. SPI Interface Protocol

For Read transactions, user first needs to write into a SDIO mode enable register for enabling the SPI read mode. Once the device is enabled for Reading, the data is driven out on the SDIO pin during the Data field of the Read Transaction.

SDIO pin is designed as a bidirectional pin for this purpose. Figure 6 shows the Read transaction. The sequence of commands that need to be issued by the SPI Master to enable SPI read mode is illustrated in Figure 12.

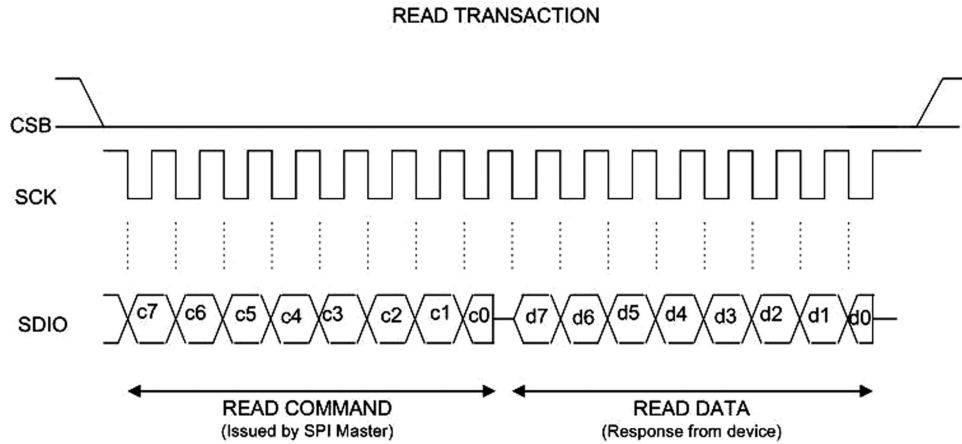

Note: Read command is issued by the SPI Master, who after issuing the c0 (LSBit of the command byte) bit should relinquish the data line (high-Z) after meeting the hold timing(10ns) and stop SCK idling high.

30164101

FIGURE 11. Read Transaction

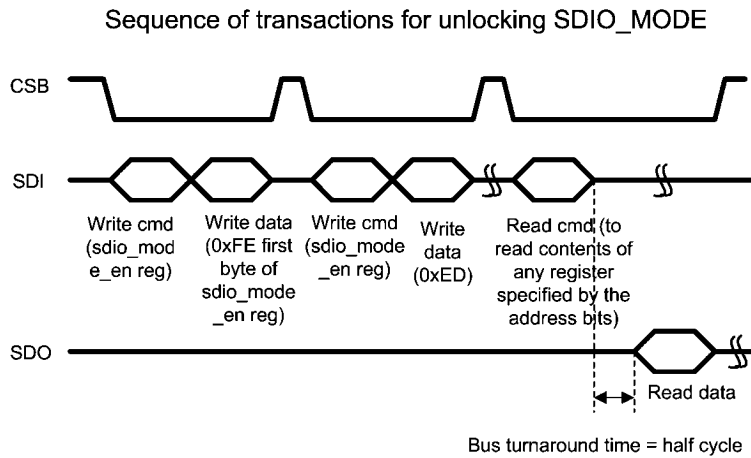

Note:

1. Once the SDIO_mode is unlocked. The user can read as many registers as long as nothing else is written to sdio_mode_en register to disturb the state of SDIO_mode
2. The separate signals SDI and SDO are given in the figure for the sake of understanding. However, only one signal SDIO exists in the design

30164115

FIGURE 12. Enable SDIO Mode for reading SPI registers

Registers Organization

Configuring the device is achieved using 'Write' of the designated registers in the device. All the registers are organized

into individually addressable byte-long registers that have a unique address. The format of the Write/ Read instruction is as shown below.

TABLE 3. Write / Read Instruction Format

Bit[7]	Bit[6:4]	Bit[3:0]
0 : Write Instruction	Reserved to 0	Address
1 : Read Instruction		

Note: Specifying any value other than zero in Bit[6:4] is prohibited.

REGISTERS

This section describes the programmable registers and the associated programming sequence, if any, for the device. The

following table shows the summary listing of all the registers that are available to the user and their power-up values.

Title	Address (Hex)	Type	Power-up/Reset Value (Hex)
Device Configuration	0x0	Read-Write (Read allowed in SDIO Mode)	0x0
DAC Configuration	0x1	Read-Write (Read allowed in SDIO Mode)	0x80
SDIO Mode Enable	0xF	Write-only	0x0

Note: Recommended values must be programmed where they are indicated in order to avoid unexpected results. Avoid writing to addresses not mentioned in the document; this could cause unexpected results.

Device Configuration – Device Configuration Register (Address 0x0)

Bit	Bit Symbol	Description
7	RESERVED	Reserved to 0.
[6:5]	EN	00: PGA1 OFF PGA2 OFF (default) 01: PGA1 OFF, PGA2 ON 10: PGA1 ON, PGA2 OFF 11: PGA1 ON, PGA2 ON
4	EXT_FILT	0: PGA1 to PGA2 direct (default) 1: PGA1 to PGA2 via external filter
3	CMN_MODE	0 : 1.15V (default) 1 : 2.59V
[2:1]	GAIN2	00: 4 (default) 01: 8 10: 16 11: 32
0	GAIN1	0: 250 (default) 1: 42

DAC Configuration – DAC Configuration Register (Address 0x1)

The output DC level will shift according to the formula
 $V_{out_shift} = -33.8mV * (NDAC - 128)$.

Bit	Bit Symbol	Description
[7:0]	NDAC	128 (0x80): $V_{out_shift} = -33.8mV * (128 - 128) = 0mV$ (default)

SDIO Mode – SDIO Mode Enable Register (Address 0xf)

Write-only

Bit	Bit Symbol	Description
[7:0]	SDIO_MODE_EN	To enter SDIO Mode, write the successive sequence 0xFE and 0xED. Write anything other than this sequence to get out of mode.

Physical Dimensions inches (millimeters) unless otherwise noted

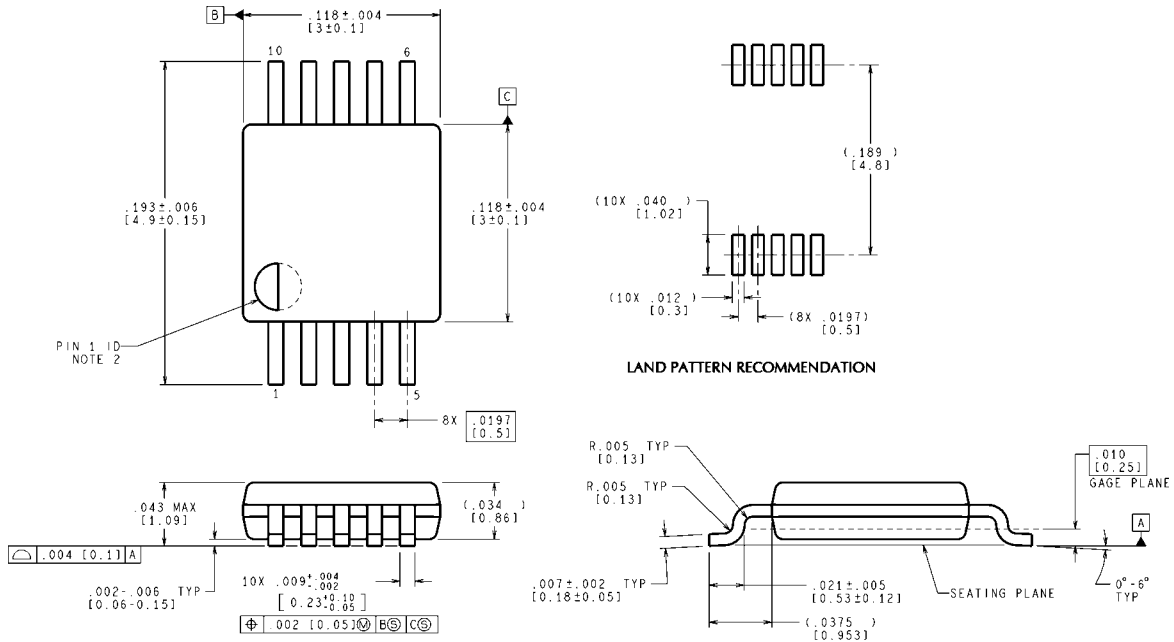

CONTROLLING DIMENSION IS INCH
VALUES IN [] ARE MILLIMETERS
DIMENSIONS IN () FOR REFERENCE ONLY

MUB10A (Rev B)

10-Lead MSOP
Order Numbers LMP91050MM/X
NS Package Number MUB10A

Notes

IMPORTANT NOTICE

Texas Instruments Incorporated and its subsidiaries (TI) reserve the right to make corrections, modifications, enhancements, improvements, and other changes to its products and services at any time and to discontinue any product or service without notice. Customers should obtain the latest relevant information before placing orders and should verify that such information is current and complete. All products are sold subject to TI's terms and conditions of sale supplied at the time of order acknowledgment.

TI warrants performance of its hardware products to the specifications applicable at the time of sale in accordance with TI's standard warranty. Testing and other quality control techniques are used to the extent TI deems necessary to support this warranty. Except where mandated by government requirements, testing of all parameters of each product is not necessarily performed.

TI assumes no liability for applications assistance or customer product design. Customers are responsible for their products and applications using TI components. To minimize the risks associated with customer products and applications, customers should provide adequate design and operating safeguards.

TI does not warrant or represent that any license, either express or implied, is granted under any TI patent right, copyright, mask work right, or other TI intellectual property right relating to any combination, machine, or process in which TI products or services are used. Information published by TI regarding third-party products or services does not constitute a license from TI to use such products or services or a warranty or endorsement thereof. Use of such information may require a license from a third party under the patents or other intellectual property of the third party, or a license from TI under the patents or other intellectual property of TI.

Reproduction of TI information in TI data books or data sheets is permissible only if reproduction is without alteration and is accompanied by all associated warranties, conditions, limitations, and notices. Reproduction of this information with alteration is an unfair and deceptive business practice. TI is not responsible or liable for such altered documentation. Information of third parties may be subject to additional restrictions.

Resale of TI products or services with statements different from or beyond the parameters stated by TI for that product or service voids all express and any implied warranties for the associated TI product or service and is an unfair and deceptive business practice. TI is not responsible or liable for any such statements.

TI products are not authorized for use in safety-critical applications (such as life support) where a failure of the TI product would reasonably be expected to cause severe personal injury or death, unless officers of the parties have executed an agreement specifically governing such use. Buyers represent that they have all necessary expertise in the safety and regulatory ramifications of their applications, and acknowledge and agree that they are solely responsible for all legal, regulatory and safety-related requirements concerning their products and any use of TI products in such safety-critical applications, notwithstanding any applications-related information or support that may be provided by TI. Further, Buyers must fully indemnify TI and its representatives against any damages arising out of the use of TI products in such safety-critical applications.

TI products are neither designed nor intended for use in military/aerospace applications or environments unless the TI products are specifically designated by TI as military-grade or "enhanced plastic." Only products designated by TI as military-grade meet military specifications. Buyers acknowledge and agree that any such use of TI products which TI has not designated as military-grade is solely at the Buyer's risk, and that they are solely responsible for compliance with all legal and regulatory requirements in connection with such use.

TI products are neither designed nor intended for use in automotive applications or environments unless the specific TI products are designated by TI as compliant with ISO/TS 16949 requirements. Buyers acknowledge and agree that, if they use any non-designated products in automotive applications, TI will not be responsible for any failure to meet such requirements.

Following are URLs where you can obtain information on other Texas Instruments products and application solutions:

Products

Audio	www.ti.com/audio
Amplifiers	amplifier.ti.com
Data Converters	dataconverter.ti.com
DLP® Products	www.dlp.com
DSP	dsp.ti.com
Clocks and Timers	www.ti.com/clocks
Interface	interface.ti.com
Logic	logic.ti.com
Power Mgmt	power.ti.com
Microcontrollers	microcontroller.ti.com
RFID	www.ti-rfid.com
OMAP Mobile Processors	www.ti.com/omap
Wireless Connectivity	www.ti.com/wirelessconnectivity

Applications

Automotive and Transportation	www.ti.com/automotive
Communications and Telecom	www.ti.com/communications
Computers and Peripherals	www.ti.com/computers
Consumer Electronics	www.ti.com/consumer-apps
Energy and Lighting	www.ti.com/energy
Industrial	www.ti.com/industrial
Medical	www.ti.com/medical
Security	www.ti.com/security
Space, Avionics and Defense	www.ti.com/space-avionics-defense
Video and Imaging	www.ti.com/video

TI E2E Community Home Page

e2e.ti.com

Mailing Address: Texas Instruments, Post Office Box 655303, Dallas, Texas 75265
Copyright © 2012, Texas Instruments Incorporated