

Master's thesis



Czech
Technical
University
in Prague

F3

Faculty of Electrical Engineering
Department of Measurement

Fast multi-channel data acquisition system for radioastronomy receiver

Jakub Kákona
Aircraft and Space Systems

June 2014

<http://wiki.mlab.cz/doku.php?id=en:sdrx>

Supervisor: Ing. Martin Matoušek, Ph.D.



ZADÁNÍ DIPLOMOVÉ PRÁCE

Student: **Bc. Jakub Kákona**

Studijní program: **Kybernetika a robotika**
Obor: **Letecké a kosmické systémy**

Název tématu česky: **Rychlý vícekanálový systém sběru dat pro radioastronomický přijímač**

Název tématu anglicky: **Fast multi-channel data acquisition system for radio-astronomy receiver**

Pokyny pro vypracování:

Proveďte rešerši a analyzujte stávající řešení vhodná pro danou aplikaci.

Navrhněte A/D modul pro digitalizaci radioastronomických dat založených na příjmu odražených pozemních signálů, ke konstrukci použijte dostupné ADC obvody. Jako datový koncentrátor pro přenos dat do PC využijte FPGA. Navrhněte připojení ADC modulů k FPGA a specifikujte požadavky na funkcionalitu implementovanou v FPGA. Výsledný VHDL design bude poskytnut.

Parametry: vzorkovací frekvence 1 MHz, možnost připojení 1 až 8 přijímačů (každý dva analogové kanály), rozlišení alespoň 12 bitů.

Návrh koncipujte škálovatelný, HW necht' sestává ze společné části a částí pro každý přijímač. Zkonstruuje funkční vzor zařízení. Využijte vývojovou desku ML605 s FPGA Virtex 6.

Převodník otestujte alespoň s jedním přijímačem a demonstřujte záznam dat a jejich zpracování.

Na základě otestování prototypu navrhněte (bez realizace) vlastní desku s FPGA a podpůrnými moduly.

Seznam odborné literatury:

- [1] Vedral, J., Fischer, J.: Elektronické obvody pro měřicí techniku. Vydavatelství ČVUT, Praha 2004, ISBN 80-01-02966-2
- [2] Richards, M.A., Scheer, J. A., Holm, W. A.: Principles of modern radar. Sci Tech Publishing, 2010, ISBN 978-1891121-52-4

Vedoucí diplomové práce: Ing. Martin Matoušek, Ph.D. (K13133)

Datum zadání diplomové práce: 14. ledna 2014

Platnost zadání do¹: 31. srpna 2015

Prof. Ing. Vladimír Haasz, CSc.
vedoucí katedry



Prof. Ing. Pavel Ripka, CSc.
děkan

V Praze dne 14. 1. 2014

¹ Platnost zadání je omezena na dobu tří následujících semestrů.

Acknowledgement / Declaration

I would like to thank Ing. Martin Matoušek, Ph.D. for his advice and ideas, and Ing. Ondřej Sychrovský for VHDL implementation of FPGA data concentrator. In addition to Fluktuacia and prof. Ing. Václav Hlaváč, CSc. for corrections of the manuscript.

This work was supported in part by the MDA project 2011-0528-01.

Prohlašuji, že jsem předloženou práci vypracoval samostatně a že jsem uvedl veškeré použité informační zdroje v souladu s Metodickým pokynem o dodržování etických principů při přípravě vysokoškolských závěrečných prací.

V Praze dne 12. 5. 2014

.....

Abstrakt / Abstract

Dnešní radioastronomická pozorování jsou kvůli rušení a potřebě získat velké úhlové rozlišení realizována jako víceantenní přijímací systémy. Takto konstruovaná zařízení mají ale značné nároky na kvalitu zpracování signálu z více kanálů. K této práci mě motivovala moje amatérská radioastronomická aktivita při sledování meteorů.

Diplomová práce se zabývá možnou realizací digitalizační části přijímače radioastronomických signálů. Popsaná realizace je optimalizována na vysoký dynamický rozsah vstupních signálů a dobrou fázovou stabilitu, což jsou nejvýznamnější parametry pro použití ve víceantenních systémech. Návrh i konstrukce jsou koncipovány jako open-source hardwarové řešení, které má zatím jedinečné parametry v oblasti přístrojů určených pro amatérskou i profesionální radioastronomii.

V diplomové práci jsem navrhl a realizoval zkušební verzi zařízení. Experimentoval jsem s ním. Ze zkušeností vyplývají doporučení pro opakovanou realizaci přijímačů, kterou chceme v amatérské síti pro sledování meteorů mnohonásobně zopakovat.

Klíčová slova: Radioastronomie, digitalizace signálu, A/D konverze

Due to the ubiquitous presence of interference and a need for a large angular resolution, the current radioastronomical observations are carried out using multi-antennas receiver systems. Construction of such devices places great demands upon the quality of signal processing. A source of inspiration for my diploma thesis has been my own amateur radioastronomical activity in the field of meteor observations. The thesis deals with a possible realization of a digitization unit for a radioastronomical signal receiver. The implementation described in the thesis is optimized for a high dynamic range and good phase stability, both being the most important parameters for its application in the multi-antennas systems. Design and the instrument implementation have been created as open-source hardware solutions, so far having unique characteristics among the devices used in amateur or professional radioastronomy. I have devised and implemented a trial version and made further experiments with it. A resulting recommendations for repeated implementations of the receivers, that we are planing to use in the amateur meteor observing networks, are based on these experiences.

Keywords: ADC interface, radioastronomy, signal digitalisation

Contents /

1 Introduction	1	4.1 Custom design of FPGA board	25
1.1 Current radioastronomy problems.....	1	4.2 Prralella board computer.....	25
1.2 Radio astronomy receiver.....	2	4.3 GPU based computational system	26
1.3 Required receiver parameters ...	3	4.4 Other ARM based computation systems	27
1.3.1 Sensitivity and noise number	3	5 Conclusions	29
1.3.2 Dynamic range	3	5.1 Possible hardware improvements	29
1.3.3 Bandwidth	4	5.2 Possible software improvements	30
1.4 State of the art in receivers' digitization units	4	Glossary	31
1.4.1 Custom digitization system	4	References	32
1.4.2 Modular digitization systems	5	A Circuit diagram of ADCdu-al01A module	35
2 Trial version of the digitizer	6	B Circuit diagram of FMC2DIFF module	36
2.1 Required parameters.....	6	C Content of enclosed CD	40
2.2 Sampling frequency	6		
2.3 System scalability	7		
2.3.1 Differential signalling	7		
2.3.2 Phase matching	7		
2.4 System description.....	8		
2.4.1 Receiver overview	8		
2.4.2 Frequency synthesis.....	8		
2.4.3 Signal cable connectors ..	10		
2.4.4 Signal integrity requirements	10		
2.4.5 ADC modules design	11		
2.4.6 ADC modules interface ..	12		
2.4.7 FPGA data concentrator	16		
2.4.8 Data reading and recording	17		
3 Results obtained in the trial version	20		
3.1 Measured parameters	20		
3.2 Example of usage	21		
3.2.1 Simple polarimeter station	21		
3.2.2 Basic interferometric station	22		
3.2.3 Simple passive Doppler radar	22		
3.2.4 Meteor detection station	24		
4 Proposition of the final system .	25		

Tables / Figures

1.1. Dynamic range versus bit depth	4	1.1. Lofar antenna configuration	3
2.1. Phase noise of the local oscillator.....	10	1.2. CASPER's ROACH data processing board	5
2.2. Available ADC types.....	12	2.1. Expected system block schematic	9
2.3. miniSAS differential pairs connections	15	2.2. Used miniSAS cable.....	11
2.4. SPI configuration interface connections	15	2.3. Single line ADC output signals	13
2.5. System clock interconnections .	15	2.4. Preview of designed ADCdual PCB.....	13
2.6. Grabber binary output format .	17	2.5. VITA57 board geometry	14
		2.6. Realized FMC2DIFF01A module.....	16
		2.7. ML605 development board	17
		2.8. Gnuradio flow graph for signal grabbing	18
		2.9. User interface window of a running ADC grabber.....	19
		3.1. Balun transformer circuit	20
		3.2. ADC1 sine test FFT	21
		3.3. ADC2 sine test FFT	21
		3.5. Phase difference	22
		3.4. Receiver block schematic	23
		3.6. Meteor reflection	24
		4.1. Parallella board overview	26
		4.2. NVIDIA Jetson TK1 Development Kit	27

Chapter 1

Introduction

1.1 Current radioastronomy problems

From a radioastronomer's point of view, it is important that radioastronomy focuses its interest primarily on natural signals originating in the surrounding universe. It does not pay much attention to the man-made signals created by our civilisation.

However, it is due to these artificial signals, that the current radioastronomy faces a disturbing issue. The problem arises from the fact, that there are too many terrestrial transmitters currently active. All of them are sources of a dense signal mixture which can cause trouble not only to radioastronomers.

As a consequence, there already exist efforts to control the radiofrequency spectrum. As result of these attempts to control the spectrum, the frequency allocation table has been created [1]. The radio-frequency allocation table contains special bands allocated to radioastronomy use. However, for many reasons these bands are not clean enough to be used in radioastronomical observations directly. As a result, we cannot work in the same way as did the radioastronomers in the very beginnings of radioastronomy. Many experiments, namely Cosmic microwave background detection or pulsar detection, cannot be realised nowadays in their original forms with satisfactory results.

Supporting evidence of such effect is RadioJOVE project. NASA engineers who originally created the RadioJOVE project had a great idea. The RadioJOVE project brought an opportunity for creating a publicly available, cheap radioastronomy receiver. However, they used an old-fashioned construction design which, on one hand, can operate in unoccupied harsh environments like deserts, but on the other hand it simply do not meet the criteria that would make it possible to be used in modern civilisation, as we know it in Europe [2]. The source of its dysfunction is a presence of strong radiofrequency interferences. These interferences are orders of magnitude stronger than Jupiter decametric emissions, whose detection was the main aim of the RadioJOVE project. From what we have already seen in the light pollution mitigation pursuit, there is only a small chance to radically improve the situation in radiofrequency spectrum.

The only way to overcome this problem is to search for new methods of radioastronomy observations, new methods which allow us to work without completely clear radiofrequency bands and which allow us to see the surrounding universe even despite the existence of man-made radiofrequency interference mixture. One solution is to use already known natural radio frequency signals parameters. Natural signals usually have different signal properties than local interference. Natural objects do not have problems with transmission in bandwidths of tens of megahertz in sub 100 MHz bands. These objects are usually far away and the same signal could be received at almost half of the Earth globe without any significant differences. On the other hand, it is obvious that signals with such parameters have some drawbacks, namely in the reception power. The reception power of radioastronomical object is $1 \cdot 10^9$ smaller than the power of signal received from a typical broadband radio transmitter.

From the above mentioned facts concerning the natural radio signals we can conclude that modern requirements imposed on a radioastronomy receiver are completely different from the requirements existing back in the history. Radioastronomy is no longer limited by an access to electronic components, today it is rather limited by the everywhere presence of electronics.

1.2 Radio astronomy receiver

At the beginnings of radioastronomy, the receivers were constructed as simple stations with a single antenna or a multiple antennas arrays with fixed phasing. This approach was used because of the existing limits of electronic components and technologies. The main challenges of those times were problems of noise number and low sensitivity, both present due to the poor characteristics of active electronic components such as transistors and vacuum tubes.

Most of the present-day operating radioastronomy equipment has been constructed in a similar manner. It was produced usually shortly after the WWII or during the Cold War as a part of the military technology.

Today, we have an access to components with much higher quality, repeatability and lower price as compared to the components accessible to previous generation of radioastronomers. That is why we are able to develop a better radioastronomical equipment, powerful enough to make new astronomical discoveries possible.¹⁾

We have the capacities necessary to develop a receiver which will have a wide bandwidth, a high third-order intercept point and preferably an option for phase and frequency locking to other receivers located at other radioastronomical sites on the Earth. Currently there exist several receivers with the above-mentioned parameters, for example USRP2, USRP B210 [3] or HackRF [4] which are commercially available. However all of them lack scalability and have higher prices unaffordable to our amateur radioastronomical network. Scalability and redundancy are the main requirements of the noise reduction algorithms and thus acted as a motivation for this diploma thesis.

New radio astronomical systems such as LOFAR [5] are explicit examples of the scalability and redundancy approach. LOFAR has a completely different and novel structure developed to solve the problems of radioastronomy signal reception. It uses exclusively multi-antenna arrays and mathematical algorithms for signal handling. Radio signals recorded by LOFAR can be used in multiple ways: radio images can be computed (if sufficient cover of u/v plane is achieved), the radiation intensity can be measured, the spectrum can be analysed for velocity measurement, etc.

LOFAR is an innovative radioastronomy system which uses a phased antenna array approach at an enormous scale. Thousands (around $2 \cdot 10^4$) of antennas are manufactured and deployed in the field. The centre of LOFAR system is situated in the Netherlands and peripheral antennas with the connection network extend to other European countries.

Due to the size of the whole system, the LOFAR project has to use a low cost hardware. A special construction techniques were employed to keep the overall project budget at acceptable level (including for example specially designed polystyrene supporting blocks for High Band Antenna (HBA)). Many of used components are manufactured on a massive scale for other than scientific use. LBA antennas' masts are made from a standard Polyvinyl chloride (PVC) plastic waste pipes 1.1. The entire project

¹⁾ Most of astronomy-related discoveries in the last fifty years came from the field of radioastronomy.



Figure 1.1. One LOFAR LBA antenna element.

was designed by the Netherlands Institute for Radio Astronomy which produces many similarly sophisticated devices [6].

1.3 Required receiver parameters

The novel approach of the receiver construction described above goes hand-in-hand with the new requirements on receiver parameters as well. No additional attempts to improve the signal-to-noise ratio on single antenna have been performed currently. There are however other parameters, that are requested nowadays.

1.3.1 Sensitivity and noise number

Sensitivity and noise number are parameters which are tied together. However, the requirement for multi-antenna and multi-receiver arrays forces to keep the prices of receivers at the minimal value. This implies that the sensitivity and noise number have to be at least as good in the detection (signal / noise > 1) of an observed object, that the object would be detected by the majority of receivers connected to an observational network.

1.3.2 Dynamic range

The dynamic range represents a huge problem of current radioastronomical receivers. It arises from the ubiquitous human activity creating an electromagnetic interference (EMI) radiation in the radio frequency (RF) band. The modern radioastronomical receivers must not be saturated by these high levels of signals but still need to have sufficient sensitivity to see faint signals from sources being observed. The dynamic range is limited either by the construction of analog circuitry in the receiver or by the digitization unit.

The maximal theoretical dynamic range of an analog-to-digital converter (ADC) could be estimated from ADC bit depth as

$$\text{dynamicrange} [dB] = 20 \cdot \log(2^n) \quad (1)$$

ADC Bits	Dynamic range [dB]
8	48
10	60
12	72
14	84
16	96
24	144

Table 1.1. Standard bit depths of ADC and its theoretical dynamic range.

The maximum theoretical dynamic range for standard bit depths of ADC is shown in the Table 1.1.

If we look at the actual spectrum occupancy in Europe (measured in the power spectral density), we see, that the signal dynamic range in spectra easily reaches more than 80 dB above the natural noise levels [7]. If we do not want to deal with the receiver’s saturation or the poor sensitivity, we need a receiver and digitization unit which has a dynamic range comparable to the received signals. This implies the use of at least 14 bit ADC which would not, however, leave any part of the range spare. The 16 bit range seems more optimal as it offers some spare range for the strongest RF signals. In addition, the two byte sample range has a good efficiency in the use of standard data types, that mostly have a length in the powers of 2. That is why we have selected the 16 bit digital range as the optimal one for our design.

■ 1.3.3 Bandwidth

Historically, the bandwidth parameter in radioastronomical receivers used to be within the kilohertz range. Such a narrow bandwidth was acceptable because observations were processed directly by listening or by a paper chart intensity recorder. The chart recorder integrated the energy of a signal over a defined narrow bandwidth which was suitable for detecting the intensity variance of a microwave background. No wide-band transmitters existed in that era (except for TV transmitters) and tuning to other neighbouring frequency was easy as they were mostly vacant. Parallel observations from several places were unnecessary as well because the electromagnetic conditions were nearly the same at all locations.

Currently we are not able to use any unused part of the radio-frequency spectrum for radioastronomical observations.

■ 1.4 State of the art in receivers’ digitization units

Only a few digitization systems dedicated to radioastronomy currently exist. Today’s systems use either a custom design of the whole receiver or they are constructed from commercially available components. Open-source principle attempts are very rare in the radioastronomy field.

■ 1.4.1 Custom digitization system

Custom designs usually use non-recurring engineering for the development of a specific solution for an observational project. Consequently, such instruments are very costly if they are not reproduced multiple times. A typical example of the instrument developed and manufactured in a single piece with enormous funding requirements was the Arecibo ALFA [8].

Another example, this time a custom-designed receiver and digitization unit design but duplicated many times is LOFAR system developed by Astron in the Netherlands [5]. Since thousands of antennas are used the project must use a low cost hardware due to system scale. The solution chosen in this project is based on low cost direct sampling receivers, combining RF part and digitizer in a single block.

1.4.2 Modular digitization systems

Due to cost restrictions in science and astronomy instruments development, a reuse of engineering work is preferable. There is one good example of a modular digitization and data processing system - a system Collaboration for Astronomy Signal Processing and Electronics Research (CASPER), that has been in development at the University of Berkeley [9] since around 2005. CASPER designers and engineers noticed a remarkable lack of such hardware in radioastronomical science. Their ideas are summarised in the following paper [10]. Unfortunately, they use a proprietary connector standard and technology. They have developed a modular system based purely on Tyco Z-DOK+ connectors family. CASPER data processing board with Z-DOK connectors is shown in the Figure 1.2. Z-DOK connectors have a relatively high pricing (around 40 USD) [11], but represent high quality differential pairs connectors. However, the price of these connectors is comparable with the price of one ADC channel in the design described in this diploma thesis.

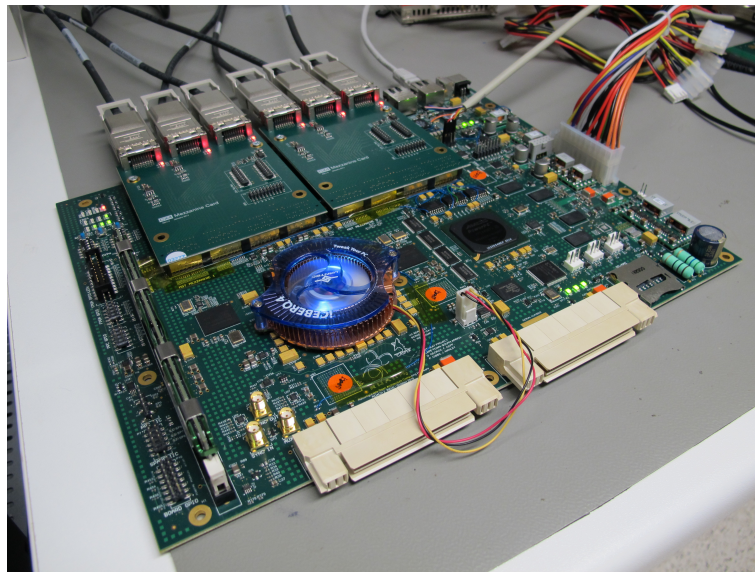

Figure 1.2. CASPER project ROACH-2 data processing board. White Z-DOK connectors for daughter ADC Boards can be easily seen in the front of the board.

On the contrary to the professional astronomers, who use proprietary digitization units, amateur radioastronomers have been using multichannel sound cards [12] or self designed digitalisation units. Devices constructed by amateurs are usually non reproducible [13]. It is evident that the current radioastronomy lacks a proper hardware which could be used by both communities, professionals and amateurs. The optimal solution in such situation should be an open-source hardware, a concept that we further develop in this diploma project.

Chapter 2

Trial version of the digitizer

The whole design of the radioastronomic receiver digitization unit is meant to be used in a wide range of applications and tasks related to digitization of a signal. A good illustrating problem for its use is the signal digitization from multiple antenna arrays. Design and implementation of the system is presented in this chapter.

2.1 Required parameters

We require the following technical parameters in order to overcome the existing digitization units solutions. Primarily, we need a wide a dynamical range and a high third-order intercept point (IP3). The receiver must accept signals with the wide dynamics because a typical radioastronomical signal is a weak signal covered by a strong man-made noise or other undesired noises as lighting, Sun emissions, etc.

The summary of other additional required parameters:

- Dynamic range better than 80 dB, see Section 1.3.2 for the explanation.
- Phase stability between channels.
- Low noise (all types).
- Sampling jitter better than 100 metres.
- Support for any number of receivers in the range of 1 to 8.

We analyze several of the parameters more in detail in the sequel.

2.2 Sampling frequency

The sampling frequency has not been a limiting factor in the trial version. Generally, the sampling frequency is mostly limited by the sampling frequencies of the analog-to-digital conversion chips available on the market and by the interface bandwidth. The combination of required parameters – dynamic range needing 16 bits at least and a minimum sampling frequency of 1 Mega-Samples Per Second (MSPS) – leads to the need of the high-end ADC chips. However, they support minimum sampling frequency 5 MSPS.

We calculated the minimal data bandwidth rate for eight receivers, 2 bytes per sample and 5 MSPS as $8 \cdot 2 \cdot 5 \cdot 10^6 = 80$ MB/sec. Such a data rate is at the limit of the actual writing speed of a classical hard disk drive (HDD) and it is almost a double the real bandwidth of USB 2.0 interface. As a result of these facts, we must use a faster interface. Such a faster interface is especially needed in cases in which we require faster sampling rates than ADC's minimal 5 MSPS sample rate. The most perspective interface for use in our type of application is USB 3.0 or PCI Express interface. However, USB 3.0 is a relatively new technology without good development tools currently available. We have used PCI Express interface as the simplest and the most reliable solution.

2.3 System scalability

Special parameters of ADC modules are required to secure scalability of analog channels. Ideally, there should be a separate output for each analog channel in ADC module. ADC module must also have separate outputs for frames and data output clocks. These parameters allow the operation at relatively low digital data rates. As a result, the digital signal can be conducted even via long wires. The modular architecture enables the separation from a central logical unit which supports optimization of a number of analog channels.

Clock and data signals will be handled distinctively in our modular scalable design. Selected ADC chips are guaranteed to have the defined clock skew between the sampling and the data output clocks. This allows taking data and frame clocks from the first ADC module only. The rest of the data and frame clocks from other ADC modules can be measured for diagnostic purposes (failure detection, jitter measurement, etc.), but these redundant signals are not used for data sampling. If more robustness is required in the final application then Data Clock Output (DCO) and FR signals may be collected from other modules and routed through a voting logic which corrects possible signal defects.

This system concept allows for scalability, which is limited technically by a number of differential signals on the host side and its computational power. There is another advantage of the scalable data acquisition system – an economic one. Observatories or end users can make a choice how much money are they willing to spent on the radioastronomy receiver system. This freedom of choice is especially useful for scientific sites without previous experience in radioastronomy observations.

2.3.1 Differential signalling

The above mentioned concept of the scalable design requires a relatively long circuit traces between ADC and the digital unit which captures the data and performs the computations. The long distance between the digital processing unit and the analog-to-digital conversion unit has the advantage in noise retention typically produced by digital circuits. Those digital circuits, such as FPGA, Ethernet or other flip-flops blocks and circuit traces work usually at high frequencies and emit the wide-band noise with relatively low power. In such cases, any increase in a distance between the noise source and the analog signal source increases S/N significantly. However, at the same time, a long distance introduces problems with the digital signal transmission between ADC and the computational unit. This obstacle should be resolved more easily in a free-space than on board routing. The high-quality differential signalling shielded cables should be used, such as massively produced and cheap SATA cables. This technology has two advantages over PCB signal routing. First, it can use twisted pair of wires for leak inductance suppression in signal path. Second, the twisted pair may additionally be shielded by uninterrupted metal foil.

2.3.2 Phase matching

The system phase stability is a mandatory condition for multi-antennas radioastronomy projects. It allows a precise, high resolution imaging of objects, increases signal to noise ratios in several observation methods and enables using of advanced algorithms for signal processing.

The high phase stability is achieved in our scalable design through centralized frequency generation and distribution with multi-output Low Voltage Emitter-coupled

logic (LVPECL) hubs (CLKHUB02A), which have equiphased outputs for multiple devices. The LVPECL logic is used on every system critical clock signal distribution hub. This logic has the advantage over the Low-voltage differential signaling (LVDS) in the signal integrity robustness. It uses higher logical levels and higher signalling currents. The power consumption of LVPECL logic is nearly constant over the operating frequency range due to the use of bipolar transistors. This arrangement minimizes voltage glitches which are typical for CMOS logic. One drawback of its parameters is a high power consumption of LVPECL logic, which reaches tens of milliamperes per device easily.

This design ensures that all system devices have access to the defined phase and the known frequency.

2.4 System description

This section deals with the description of the trial version based on Xilinx ML605 development board, see Figure 2.7, available at the workplace. This FPGA parameters are more than sufficient of what we need for the fast data acquisition system being developed.

2.4.1 Receiver overview

Expected system configuration is shown in Figure 2.1. The system consists of antennas equipped by preamplifier (LNA) and optionally by band pass filter (BPF). The signal is conducted to down-converting mixers after amplification. Mixers are connected to precise local oscillator (GPSDO01A) controlled from PC by I²C bus. Down-converted signal is digitized by ADCdual01A modules. The ADC modules are connected using FMC2DIFF01A adapter board to data concentrator realized by FPGA board.

In this thesis, the ADC module, adapter board, FPGA specification is proposed. The other modules of the receiver system are currently existing.

2.4.2 Frequency synthesis

We have used a centralized topology as a basis for frequency synthesis. One precise high-frequency and low-jitter digital oscillator (GPSDO) has been used [14]. The other working frequencies have been derived from it by the division of its signal. This central oscillator has a software defined GPS disciplined control loop for frequency stabilization.¹⁾ We have used new methods of software frequency monitoring and compensation in order to meet modern requirements on the radioastronomy equipment, which needs the precise frequency and phase stability over a wide baseline scales for effective radioastronomy imaging.

The GPSDO device consists of Si570 chip with LVPECL output. The phase jitter of the GPS disciplined oscillator is determined mainly by Si570 phase noise. Parameters of the Si570 are summarized in Table 2.1 (source [15]).

GPSDO design, which is included in the data acquisition system, has a special feature – it generates time marks for a precise time-stamping of the received signal. Time-stamps are created by disabling the local oscillator outputs, connected to SDRX01B receivers, for 100 μ s. As the result, a rectangular click in the ADC input signal is

¹⁾ SDGPSDO design has been developed in parallel to this diploma project as a related project, but it is not explicitly required by the thesis itself and thus it is described in a separate document.

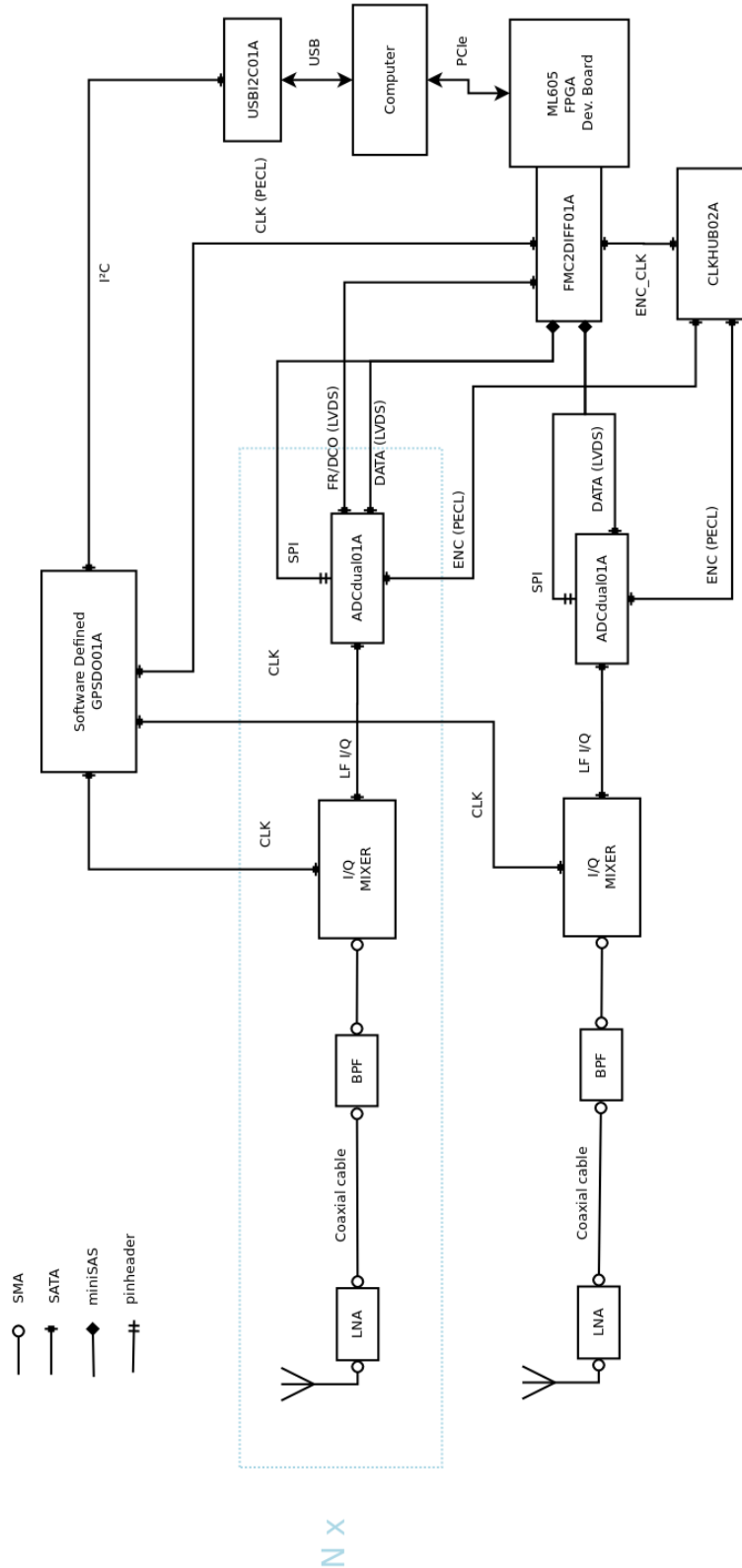

Figure 2.1. Expected realization of signal digitalisation unit.

created, which appears as a horizontal line in the spectrogram. Time-stamps should be seen in the image in Figure 3.6 (above and below the meteor reflection).

Time-stamping should be improved in future by digitization of GPS signal received by the antenna on the observational station. Following that, the GPS signal can be directly sampled by a dedicated receiver and one separate ADC module. The datafile consists of samples from channels of radio-astronomy receivers along with the GPS signal containing the precise time information.

Offset Frequency	Phase Noise [dBc/Hz]	
	F_{out} 156.25 MHz	F_{out} 622.08 MHz
100 [Hz]	-105	-97
1 [kHz]	-122	-107
10 [kHz]	-128	-116
100 [kHz]	-135	-121
1 [MHz]	-144	-134
10 [MHz]	-147	-146
100 [MHz]	n/a	-148

Table 2.1. The phase noise of the used Silicon Laboratories Si570 chip. Offset frequency is measured from carrier frequency. Values shown in the table are given for two different carrier frequencies. Adopted from [15].

Every ADC module will be directly connected to CLKHUB02A module which takes sampling clock signal delivered by FPGA from the main local oscillator. This signal should use high quality differential signalling cable – we should use SATA cable for this purpose. FPGA may slightly affect the clock signal quality by adding a noise, but it has a negligible effect on the application where developed system will be used.

2.4.3 Signal cable connectors

Several widely used and commercially easily accessible differential connectors were considered to be used in our design:

- HDMI,
- SATA,
- DisplayPort, or
- SAS/miniSAS.

Finally, MiniSAS connector was chosen as the best option to be used in connecting multiple ADC modules together. A transition between SATA and miniSAS is achieved by SAS to SATA adapter cable, which is commonly used in servers to connect SAS controller to multiple SATA hard disc in RAID systems and thus is commercially easily available. It is compatible with existing SATA cabling systems and aggregates multiple SATA cables to a single connector. It also has SPI configuration lines which can be seen in Figure 2.2 as the standard pinheader connector. The main drawback of miniSAS PCB connectors lies in the fact, that they are manufactured in SMT versions only. SMT design may eventually decrease the durability of the connector even if the outer metal housing of the connector is designed to be mounted using a standard through-hole mounting method.

2.4.4 Signal integrity requirements

We use ADC devices that have DATA clock frequency eight times higher than sampling frequency in a single line output mode, implying a 40 MHz output bit rate. This implies a $t_s = 25$ ns time length of data bit, which is equivalent to 7.5 m light path in a free

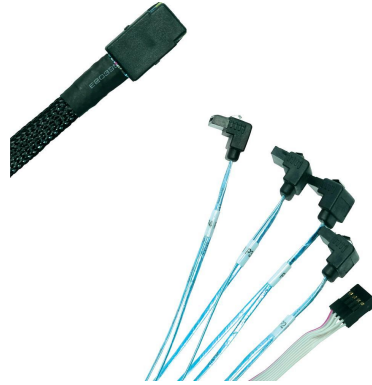

Figure 2.2. An example of a miniSAS cable.

space. If the copper PCB with FR4 substrate layer or the coaxial/twinax cable is used, we could obtain the velocity factor of 0.66 in the worst case. Consequently, the light path for the same bit rate t_s will be 4.95 m. Although we do not have any cables in the system with comparable lengths, the worst data bit skew described by data sheets of the used components is $0.3 \cdot t_s$, which is 1.485 m. Therefore the length matching is not critical in our current design operating on the used sampling speed. The length matching may become critical in future versions with higher sampling rates, where the cable length must be matched. However SATA cabling technology is already prepared for that case and matched SATA cables are a standard merchandise.

■ 2.4.5 ADC modules design

There exist several standard ADC signalling formats currently used in communication with FPGA:

- DDR LVDS,
- JEDEC 204B,
- JESD204A,
- Paralel LVDS,
- Serdes,
- serial LVDS.

As a result of our need to use the smallest number of cables possible, the choice fell on the serial LVDS format. A small number of differential pairs is an important parameter determining the construction complexity and reliability [16]. No many currently existing ADC devices have this kind of digital interface. An ultrasound AFE device chips seem to be ideal for this purpose – the chip has integrated both front-end amplifiers and filters. It has a drawback though. It is incapable of handling the differential input signal and has a relatively low dynamic range (as it consists only of 12bit ADC) and has many single ended ADC channels. Consequently, the scaling is possible only by a factor of 4 receivers (making 8 analog single ended channels).

If we add a requirement of a separate output for every analog channel and a 16bit depth, we find that there are only a few 2-Channel simultaneous sampling ADCs currently existing which meet these criteria. We have summarized those ADCs in Table 2.2.

All parts in this category are compatible with one board layout. The main differences lay in the sampling frequency and in the signal to noise ratio, with the slowest having a maximum sampling frequency of 20 MSPS. However, all of them have a minimal sampling frequency of 5 MSPS and all are configurable over a serial interface (SPI). SPI

ADC Type	LTC2271	LTC2190	LTC2191	LTC2192	LTC2193	LTC2194	LTC2195
SNR [dB]	84.1	77	77	77	76.8	76.8	76.8
SFDR [dB]	99	90	90	90	90	90	90
S/H Bandwidth [MHz]	200				550		
Sampling rate [MSPS]	20	25	40	65	80	105	125
Configuration	SPI						
Package	52-Lead (7mm × 8mm) QFN						

Table 2.2. The summary of the currently available ADC types and their characteristics.

seems to be a standard interface used in high-end ADC chips made by the largest manufacturers (Analog Devices, Linear technology, Texas instruments, Maxim integrated, etc.). For the first testing realisation, we have selected two slowest types for our evaluation design – LTC2271 and LTC2190. Following that, a PCB for this part have been designed. We have decided that ADCdual01A modules will have a standard MLAB construction layout with four mounting holes in corners aligned in defined raster of 400 mils.

Data serial data outputs of ADC modules should be connected directly by LVDS signalling levels conducted by SATA cables to FPGAs for the basic primary signal processing. The ADC chips used in the modules have a selectable bit width of data output bus and thus the output SATA connectors have signals arranged to contain a single bit from every ADC channel. This creates a signal concept enabling a selection of the proper bus bit-width according to the sampling rate (the higher bus bit-width downgrades signalling speed and vice versa.)

In order to connect the above mentioned signalling layout, miniSAS to multiple SATA cable is used as described in Section 2.4.3.

KiCAD design suite had been chosen for PCB layout. As a part of work on the thesis, new PCB footprints for FMC, SATA, ADCs a and miniSAS connectors have been designed and were committed to official KiCAD GitHub library repository. Thus, they are now publicly available.

ADCdual01A module has several digital data output formats. Difference between these modes lays in the number of differential pairs used:

- 1-lane mode,
- 2-lane mode,
- 4-lane mode.

All of the above-mentioned modes are supported by the module design. For the discussed data acquisition system, the 1-lane mode was selected. The 1-lane mode allows a minimal number of differential pairs between ADCdual01A and FPGA. Digital signalling scheme used in the 1-lane mode is shown in Figure 2.3.

ADCdual01A parameters can be set either by jumper setup (referred to as a parallel programming in the device’s data sheet) or by SPI interface. SPI interface has been chosen for our system, because of the parallel programming’s lack of options (test pattern output setup for example).

Figure 2.4 shows realized ADCdual01A module. Complete schematic diagram of ADCdual01A module board is included in Appendix A.

■ 2.4.6 ADC modules interface

Both of the ADCdual01A modules were connected to FPGA ML605 board trough FMC2DIFF01A adapter board. The design of this adapter expects the presence of FMC LPC connector on host side. It is designed to meet the VITA 57 standard specifications

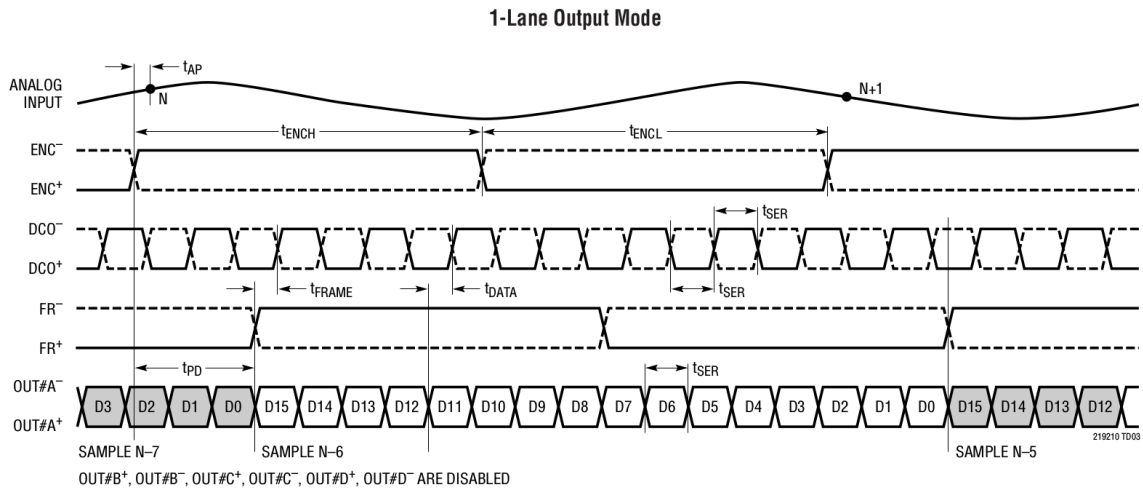

Figure 2.3. Digital signalling schema for 1-line ADC digital output mode.

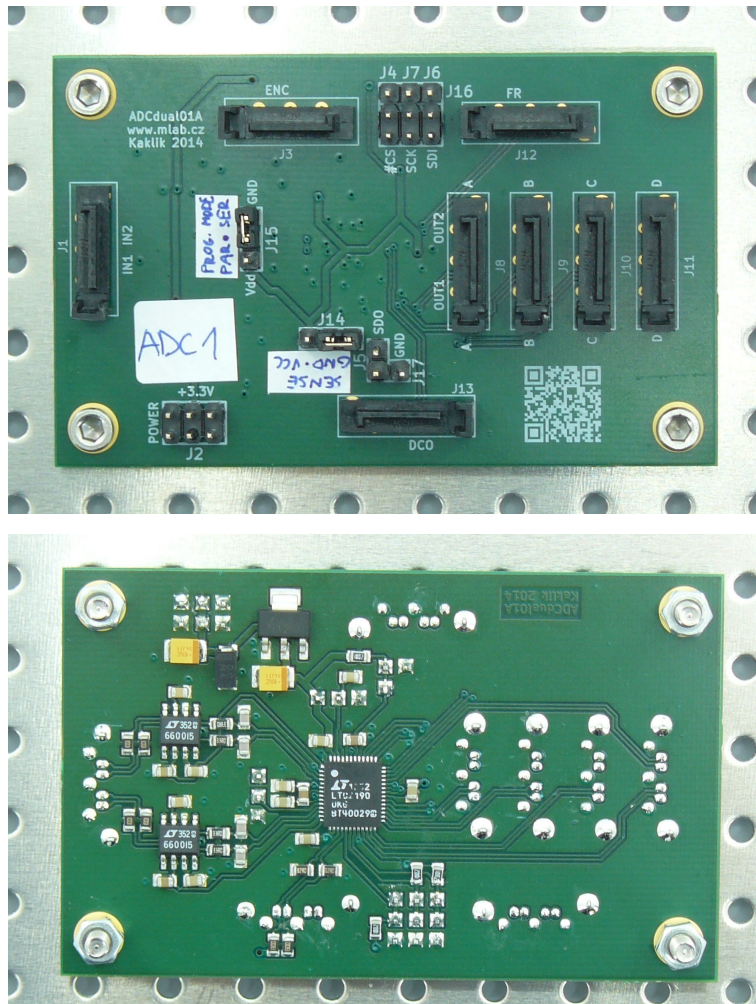

Figure 2.4. Realised PCB of ADCdual01A module. Differential pairs routings are clearly visible.

for boards which support region 1 and region 3. VITA 57 regions are explained in Figure 2.5. This industry standard guarantees the compatibility with other FPGA

boards that have FMC LPC connectors for Mezzanine Card. Schematic diagram of designed adapter board is included in Appendix B.

The primary purpose of the PCB is to enable the connection of ADC modules located outside the PC case with ML605 development board. (In PC box analog circuits cannot be realized without the use of massive RFI mitigation techniques). Differential signalling connectors should be used for conducting digital signal over relatively long cables. The signal integrity sensitive links (clocks) are equipped with output driver and translator to LVPECL logic for better signal transmission quality.

LVPECL level signal connectors on FMC2DIFF01A board are dedicated to transmit the clock signals. We have selected the SY55855V and SY55857L dual translators. Dual configuration is useful due to fact, that SATA cable contains two differential pairs.

The SY55855V is a fully differential, CML/PECL/LVPECL-to-LVDS translator. It achieves LVDS signalling up to 1.5Gbps, depending on the distance and the characteristics of the media and noise coupling sources. LVDS is intended to drive 50 Ω impedance transmission line media such as PCB traces, backplanes, or cables. SY55855V inputs can be terminated with a single resistor between the true and the complement pins of a given input [17].

The SY55857L is a fully differential, a high-speed dual translator optimized for accepting any logic standard from the single-ended TTL/CMOS to differential LVDS, HSTL, or CML and translate it to LVPECL. Translation is guaranteed for speeds up to 2.5Gbps (2.5GHz toggle frequency). The SY55857L does not internally terminate its inputs, as different interfacing standards have different termination requirements[18].

Inputs of both used chips are terminated accordingly to the used logic. The LVDS input is terminated differentially by 100 Ω resistor between the positive and the negative inputs. PECL input is terminated by Thevenin resistor network. Thevenin termination method was selected as optimal one, due to the absence of a proper power voltage (1.3 V) for the direct termination by 50 Ω resistors. Termination on FPGA side is realized directly by settings the proper digital logic type on input pins.

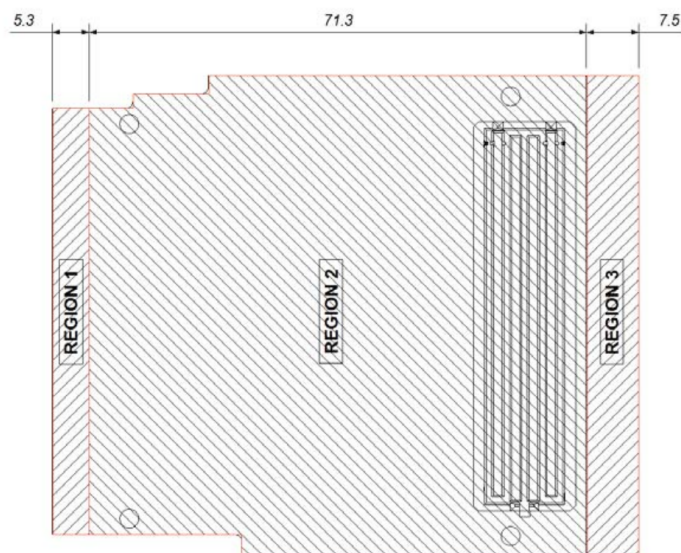

Figure 2.5. Definition of VITA57 regions.

Three differential logic input/output, one PECL input and one PECL output SATA connectors and two miniSAS connectors are populated on this board. This set of

connectors allows a connection of any number of ADC modules within the range of 1 to 8. ADC data outputs should be connected to the miniSAS connectors, while other supporting signals should be routed directly to SATA connectors on adapter.

Lengths of the differential pairs routed on PCB of the module are not matched between the pairs. The length variation of differential pairs is not critical in our design according to facts discussed in Section 2.4.5. Nevertheless, signals within differential pairs themselves are matched for length. Internal signal trace length matching of differential pairs is mandatory in order to minimize jitter and avoid a dynamic logic hazard conditions on digital signals, that represents the worst scenario. Thus the clocks signals are routed in the most precise way on all designed boards.

The signal configuration used in our trial design is described in Tables 2.3, 2.4 and 2.5.

miniSAS	SATA pair	FMC signal	Used as
P0	1	LA03	not used
P0	2	LA04	not used
P1	1	LA08	not used
P1	2	LA07	not used
P2	1	LA16	ADC1 CH1 (LTC2190)
P2	2	LA11	ADC1 CH2 (LTC2190)
P3	1	LA17	ADC2 CH1 (LTC2271)
P3	2	LA15	ADC2 CH2 (LTC2271)

Table 2.3. miniSAS (FMC2DIFF01A J7) signal connections between modules.

SPI connection J7	FMC signal	Connected to
SAS-AUX1	LA14_N	SPI DOUT
SAS-AUX2	LA14_P	SPI CLK
SAS-AUX3	LA12_N	CE ADC1
SAS-AUX4	LA12_P	CE ADC2
SAS-AUX5	LA13_N	soldered to GND
SAS-AUX6	LA13_P	not used
SAS-AUX7	LA09_N	not used
SAS-AUX8	LA09_P	soldered to GND

Table 2.4. SPI system interconnections.

SPI interface is used in an unusual way in this design. SPI Data outputs from ADCs are not connected anywhere and read back is not possible, thus the configuration written to registers in ADC module cannot be validated. We have not observed any problems with this system, but it may be a possible source of failures.

Realized FMC2DIFF01A module is shown in Figure 2.6.

Signal	FMC signal	FMC2DIFF01A	ADCdual01A
DCO	CLK1_M2C	J5-1	J13-1
FR	LA18_CC	J10-1	J12-1
ENC	LA01_CC	J2-1(PECL OUT)	J3-1
SDGPSDO01A LO	CLK0_M2C	J3-1 (PECL IN)	N/A

Table 2.5. Clock system interconnections.

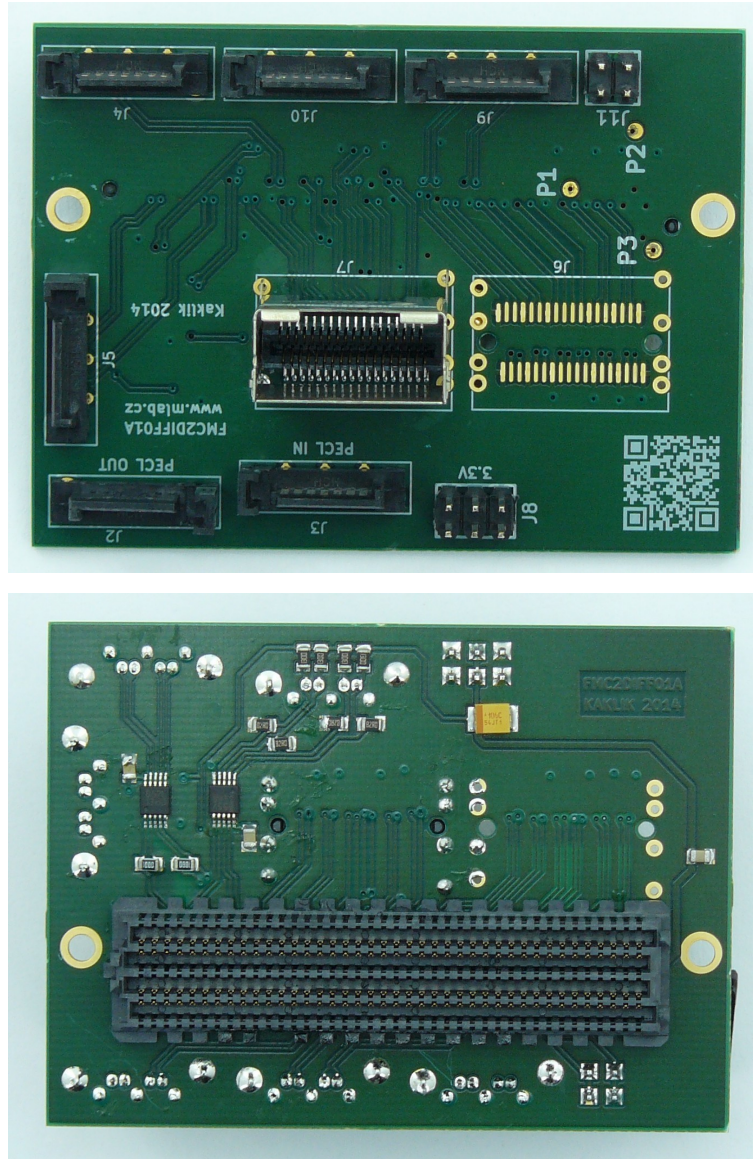

Figure 2.6. Realised PCB of FMC2DIFF01A module.

2.4.7 FPGA data concentrator

This section describes a specification of data concentrator built using FPGA board. The HDL implementation was created by my colleague Ondřej Sychrovský. Detailed description of the currently implemented FPGA functions can be found in a separate paper [19].

Several tasks in the separate IP blocks are performed by FPGA. In the first block, the FPGA prepares a sampling clock for ADCdual01A modules by dividing the signal from the main local oscillator. This task represents a separate block in FPGA and runs asynchronously to other logical circuits. The second block is a SPI configuration module, which sends configuration words to ADC modules and it is activated by opening of Xillybus interface file. The third block represents the main module, which resolves ADC – PC communication itself and it communicates via PCIe, collect data from ADC hardware and creates data packet, Table 2.6. The last block is activated after the ADC is configured via SPI.

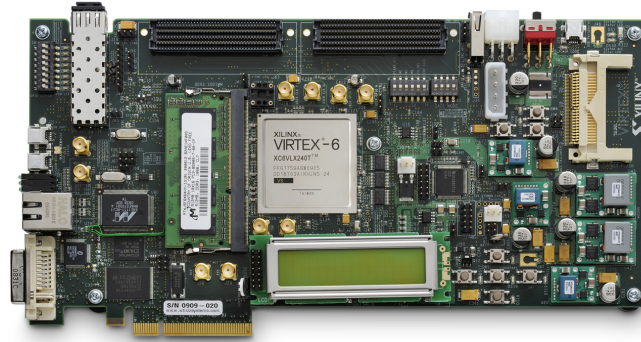

Figure 2.7. FPGA ML605 development board.

The communication over PCIe is managed by proprietary IP Core and Xillybus driver, which transfers data from FPGA registers to host PC. Data appear in a system device file named `/dev/xillybus_data2_r` on the host computer. Binary data which appear in this file after its opening are shown in Table 2.6.

	160bit packet								
Data name	FRAME	ADC1	CH1	ADC1	CH2	ADC2	CH1	ADC2	CH2
Data type	uint32	int16	int16	int16	int16	int16	int16	int16	int16
Content	saw signal	t_1	t_{1+1}	t_1	t_{1+1}	t_1	t_{1+1}	t_1	t_{1+1}

Table 2.6. System device `/dev/xillybus_data2_r` data format.

The data packet block which is carried on PCI Express is described in Table 2.6. The data packet consist of several 32bit words. The first word contains FRAME number and it is filled with saw signal for now, with incremental step taking place every data packet transmission. The following data words contain samples from ADCs' first and second channel. Samples from every channel are transmitted in pairs of two samples. Number of ADC channels is expandable according to the number of physically connected channels. An CRC word may possibly be added in the future to the end of the transmission packet for data integrity validation.

FRAME word at the beginning of data packet, now filled with incrementing and overflowing saw signal, is used to ensure that no data samples are lost during the data transfers from FPGA. FRAME signal may be used in the future for pairing the ADC samples data packet with another data packet. This new additional data packet should carry meta-data information about the sample time jitter, current accuracy of the local oscillator frequency etc.

HDL source codes for FPGA at a state in which it was used are included on the enclosed CD. Future development versions will be publicly available from MLAB sources repository [20].

■ 2.4.8 Data reading and recording

In order to read the data stream from the ADC drive, we use Gnuradio software. Gnuradio suite consists of gnuradio-companion package which is a graphical tool for

creating signal-flow graphs and generating Python flow-graph source code. This tool has been used to create a basic RAW data grabber to record and interactively view waterfall plots using the data streams output from ADC modules. The ADC recorder flow graph is shown in Figure 2.8.

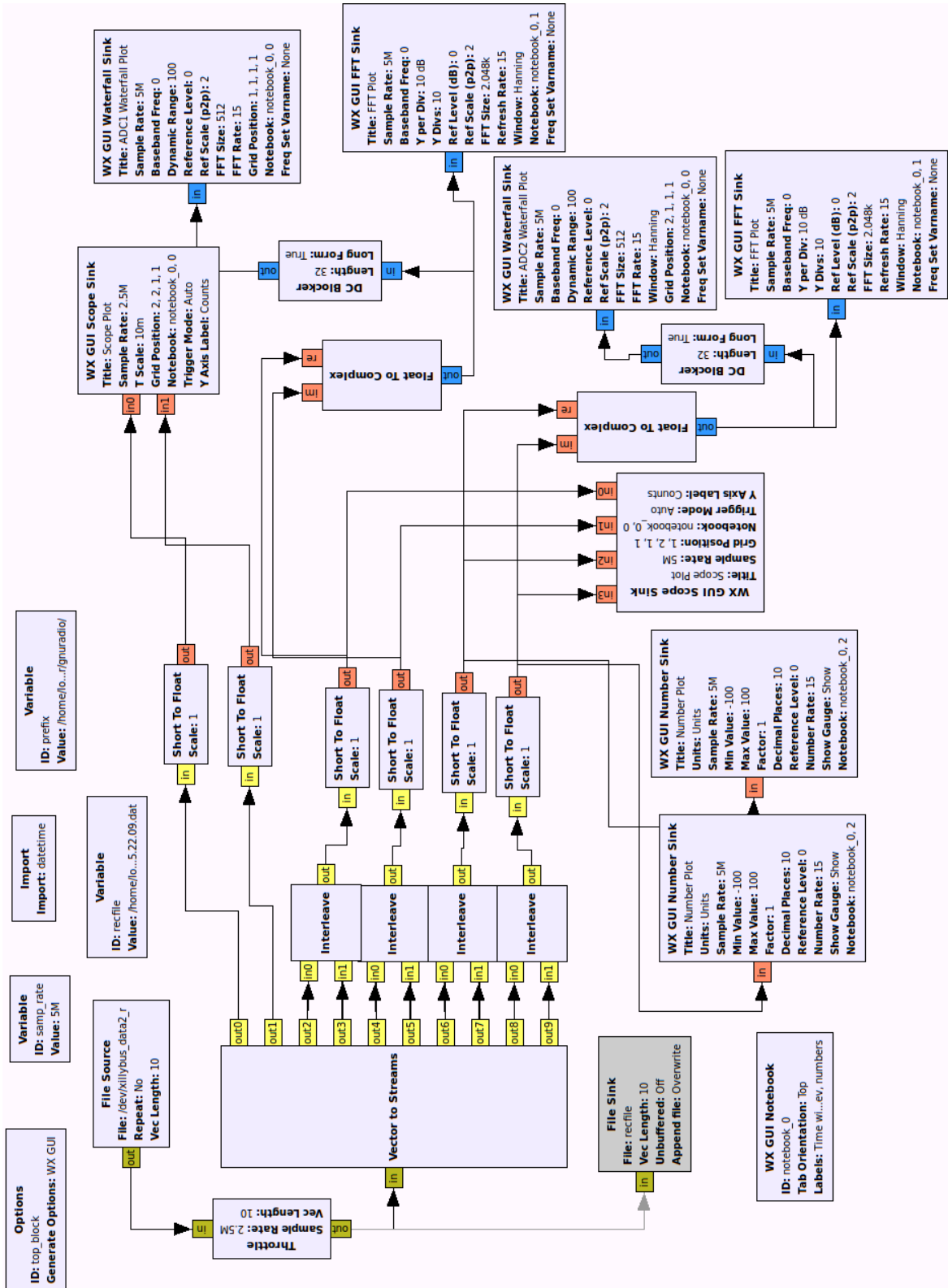

Figure 2.8. The ADC recorder flow graph created in gnuradio-companion.

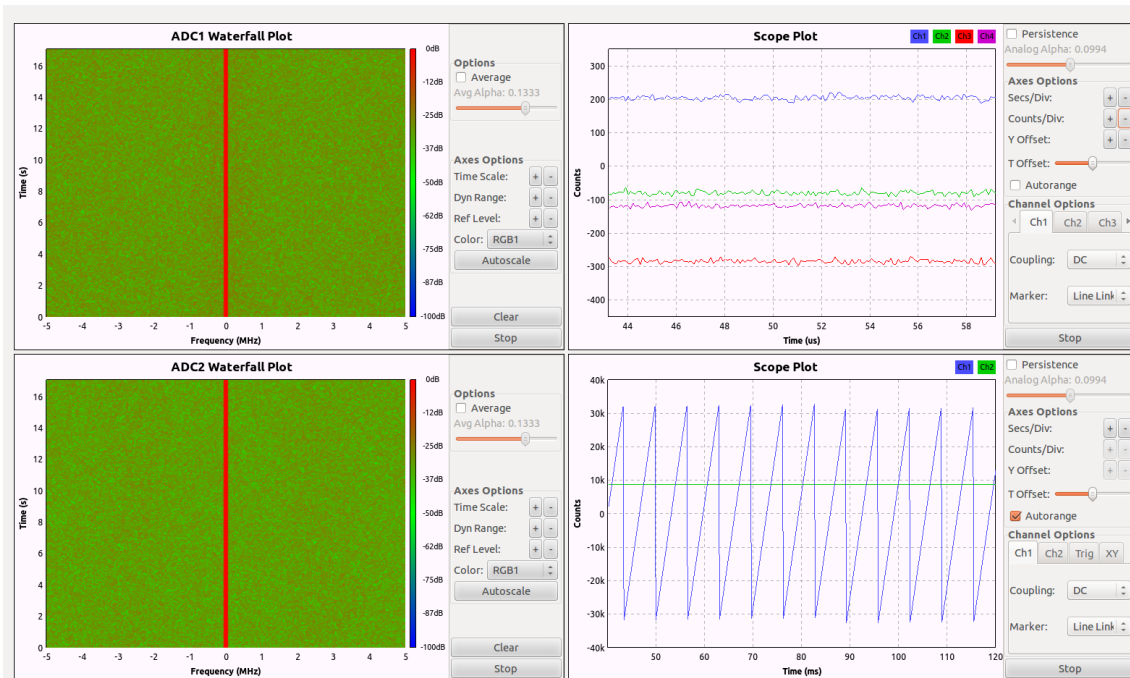

Figure 2.9. User interface window of a running ADC grabber.

The interactive grabber-viewer user interface shows live oscilloscope-like time-value display for all data channels and live time-frequency scrolling display (a waterfall view) for displaying the frequency components of the grabbed signal. The signal is grabbed to the file with the exactly same format as described in Table 2.6. An example of interactive grabber-viewer showing a part of the grabbed signal is in Figure 2.9.

Chapter 3

Results obtained in the trial version

The trial version construction was tested for proper handling of sampling rates in the range of 5 MSPS to 15 MSPS, but it should work even above this limit. The system works on i7 8 cores computer with Ubuntu 12.04 LTS operating system. Data recording of input signal is impossible above the sampling rates of around 7 MSPS due to the bottleneck at HDD speed limits, but it should be resolved by the use of SSD disk drive. However, such design has not been tested in our setup.

3.1 Measured parameters

Two prototypes of ADC modules were assembled and tested. The first prototype, labeled ADC1, has LTC2190 ADC chip populated with LT6600-5 front-end operational amplifier. It has also a 1 kOhm resistors on inputs which give it an ability of the internal attenuation of the input signal. The value of this attenuation A is calculated as

$$A = \frac{806 R_1}{R_1 + R_2}, \quad (1)$$

where

- A - Gain of the input amplifier,
- R_1 - Output impedance of the signal source (usually 50Ω),
- R_2 - Value of serial resistors at operational amplifier inputs.

We have $R_2 = 1000 \Omega$ and $R_1 = 50 \Omega$ which implies that $A = 0.815$. This value of A was also confirmed by the measurement. In our measurement setup, we have H1012 Ethernet transformer connected to inputs of ADC. We have used this transformer for signal symetrization from BNC connector at Agilent 33220A signal generator, see Figure 3.1.

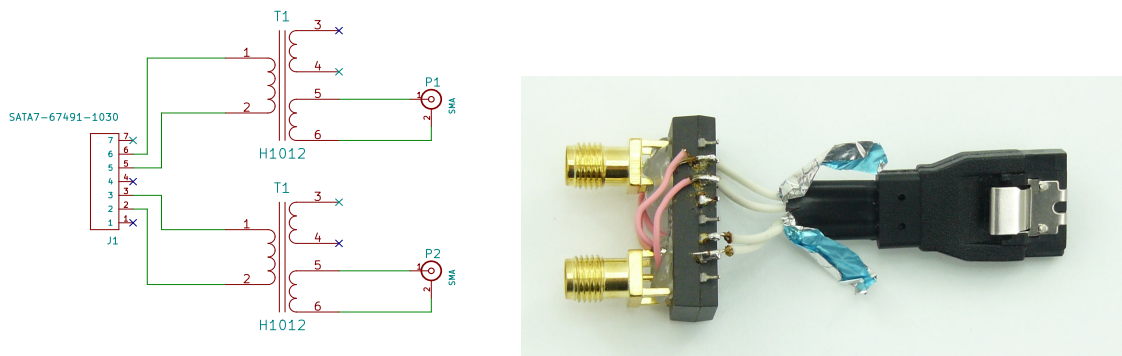

Figure 3.1. Simplified balun transformer circuit diagram (left) and balun transformer constructed from H1012 transformer salvaged from an old Ethernet card (right).

The signal generator Agilent 33220A, which we used, does not have optimal parameters for this type of dynamic range measurement. The signal distortion and spurious levels are only -70 dBc according to Agilent datasheet [21]. We have managed to measure ADC saturation voltage of 706 mV (generator output) with this setup. The main result of our measurement, seen as a FFT plot shown in Figure 3.2, confirms the dynamic range >80 dB at ADC module input.

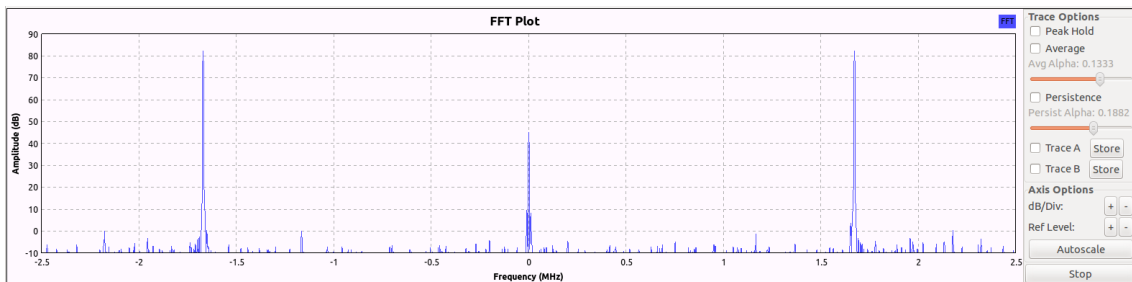

Figure 3.2. Sine signal sampled by ADC1 module with LTC2190 and LT6600-5 devices.

Similar test was performed with ADC2 module. For ADC2 we have to use formula with a different constant

$$A = \frac{1580R_1}{R_1 + R_2}. \quad (2)$$

The ADC2 module has LT6600-2.5 amplifiers populated on it with a gain equal to $A = 2.457$ and uses the same R_2 resistors. We measured the saturation voltage of 380 mV (generator output) at the channel 1 on this ADC. It is well within the parameter tolerances of the used setup. Again, FFT plot shown in Figure 3.3 confirms the dynamic range > 80 dB.

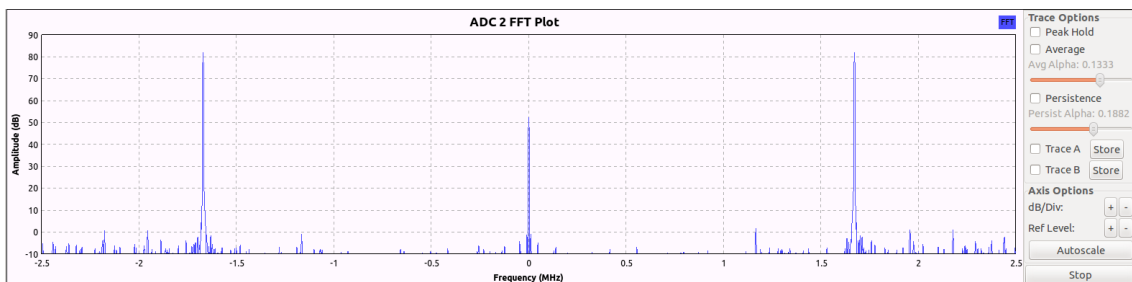

Figure 3.3. Sine signal sampled by ADC2 module with LTC2271 and LT6600-2.5 devices.

3.2 Example of usage

At current state, the constructed radioastronomy digitization unit paired with SDRX01B receiver module could be used in several experiments. We describe overall ideas of these experiments and show preliminary results in cases where we obtain the data.

3.2.1 Simple polarimeter station

If we use two antennas with different linear polarization (Crossed Yagi antennas for example), we should determine the polarization state of the received signal. Such kind of measurement is useful if we need an additional information about the reflection

to distinguish between targets. This configuration needs a more complicated antenna configuration. We had no experience with this type of observation, so we did not implement this experiment. However, this is exactly the scenario the system is designed for.

3.2.2 Basic interferometric station

The interferometry station was chosen to serve as the most basic experimental setup. We connected the new data acquisition system to two SDRX01B receivers. The schematic diagram of the setup used is shown in Figure 3.4. Two ground-plane antennas were used and mounted outside the balcony of the CTU building at the location $50^{\circ} 4' 36.102''$ N, $14^{\circ} 25' 4.170''$ E. Antennas were equipped with LNA01A amplifiers. All coaxial cables had the same length of 5 meters. Antennas were isolated by the common mode ferrite bead mounted on the cable to minimise the signal coupling between antennas. The evaluation system consisted of SDGPSDO local oscillator subsystem used to tune the local oscillator frequency.

Despite of the schematic diagram proposed at beginning of system description 2.1, we have used two separate oscillators. One oscillator drives ENC signal to ADCs still through FPGA based divider and the second oscillator drives it to SDRX01B mixer.

The reason for this modification was an attempt to simplify the frequency tuning during the experiment. A single oscillator may be used only with a proper setting of FPGA divider. This divider may be modified only by the recompilation of FPGA code and loading/flashing a new FPGA design. Due to fact that the FPGA is connected to PCI express and kernel drivers with hardware must be reinitialized, the reboot of PC is required every time a FPGA design is changed. Instead of this complicated procedure, we set the FPGA divider to a constant division factor of 30 and used another district oscillator for ADCdual01 sampling modules and for SDRX01B receiver. We have used ACOUNT02A MLAB instrument for frequency checking of the correct setup on both local oscillators.

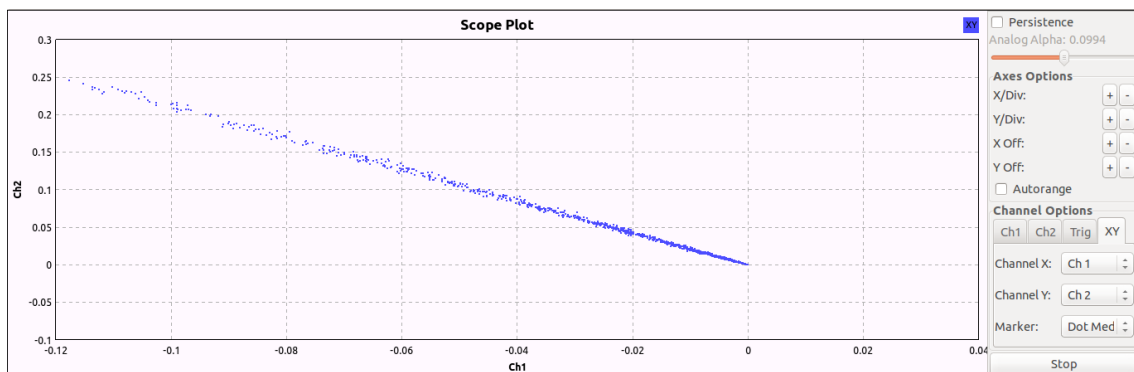

Figure 3.5. Demonstration of the phase difference between antennas.

For the simplest demonstration of the phase difference between antennas, we have analyzed part of the signal by the complex conjugate multiplication between channels. Results of this analysis can be seen in the following picture, see Figure 3.5. Points of the selected part of the signal create a clear vector, which illustrates the presence of the constant phase difference determined by RF source direction.

3.2.3 Simple passive Doppler radar

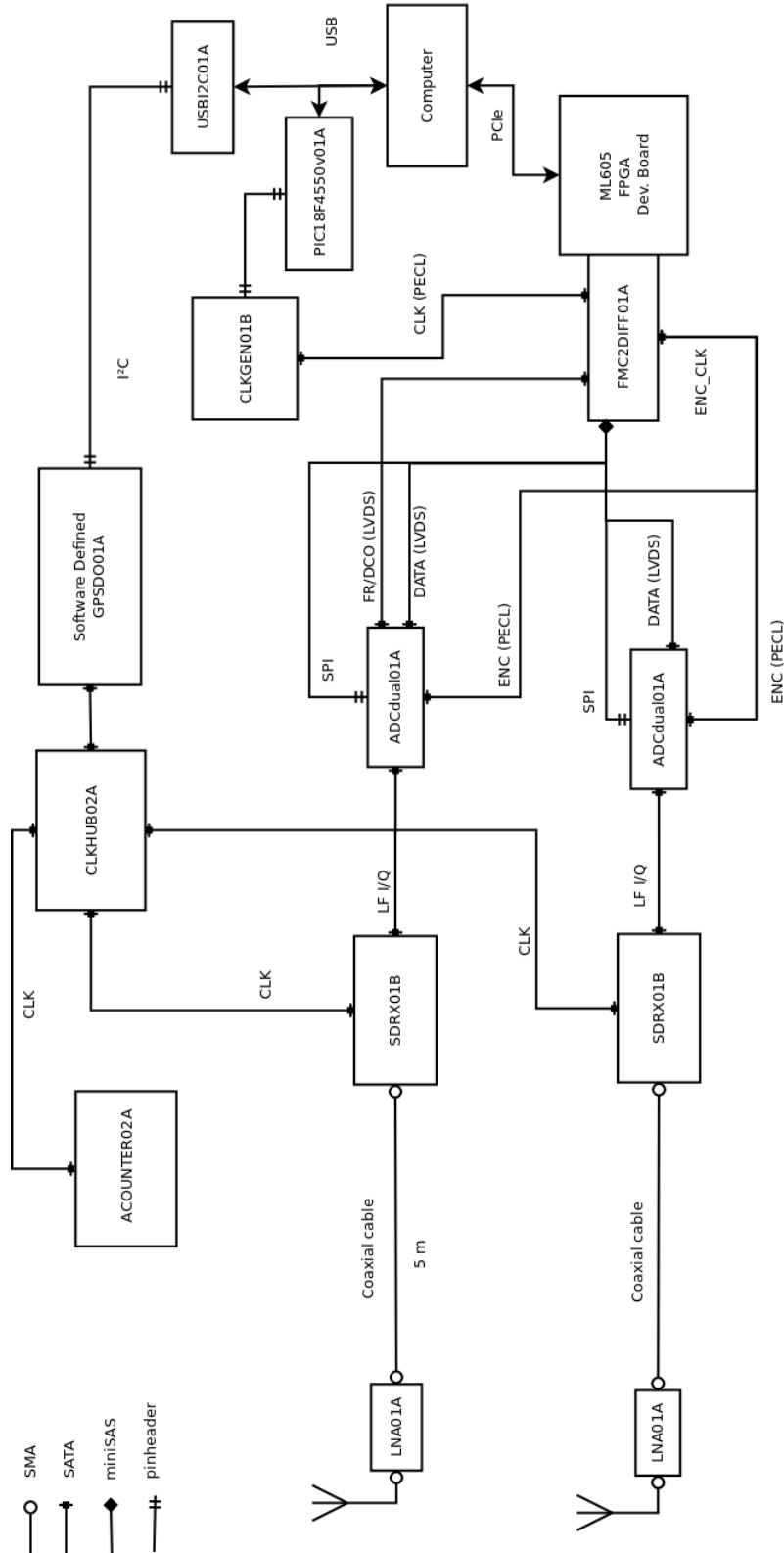

Figure 3.4. The complete receiver block schematic diagram of the dual antenna interferometric station.

If we use the existing transmitter with the known carrier frequency and a proper antenna, we can detect a flying object as signals surrounding the transmitter carrier frequency. We planned this experiment with the same station configuration as was

described in Section 2.1. The International Space Station (ISS) as the object and GRAVES radar transmitter were selected as adequate testing objects. (We know ISS reflections from previous experiments). This experiment could be realized by the interferometer station described previously. However, we missed unfortunately the suitable orbit pass due to technical lacks with station configuration.

3.2.4 Meteor detection station

The same observational station configuration should be used for the meteor detection system [22]. We used the GRAVES radar as a suitable signal source and we monitored its carrier frequency. GRAVES radar is located in France therefore we could not see its direct carrier signal, but meteors reflect it signal. As the consequence, we could easily detect the meteor presence as the reflection appearance. One meteor detected by this method is shown in Figure 3.6.

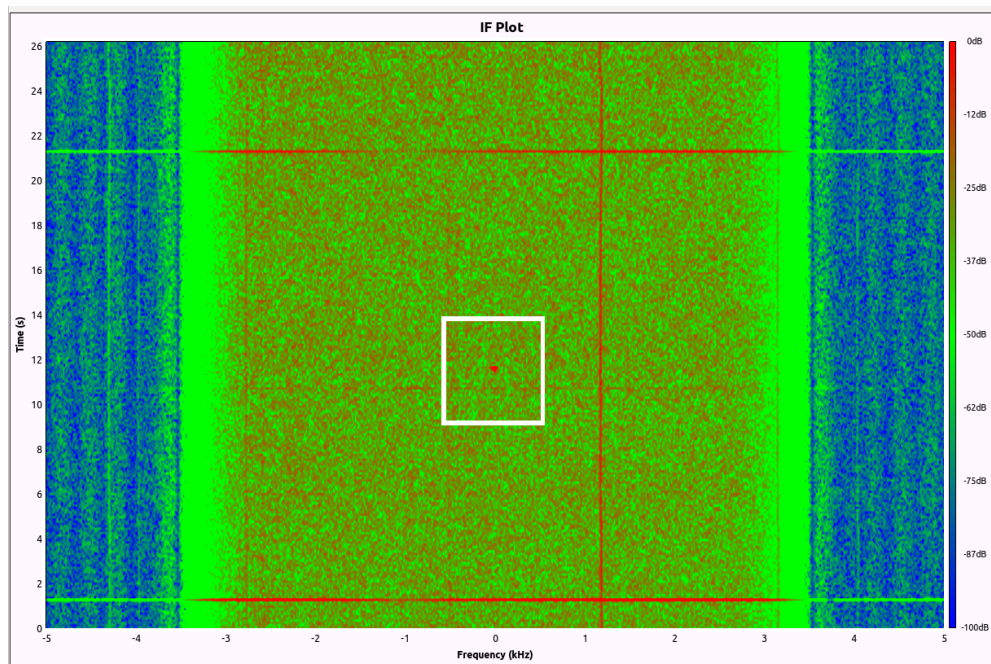

Figure 3.6. Meteor reflection (the red spot in centre of image) received by an evaluation design.

Chapter 4

Proposition of the final system

The construction of the final system, which is supposed to be employed for real radioastronomy observations, is described in this chapter. It deals mainly with the theoretical analysis of the data handling systems. The implementation of the described ideas might be possible as part of our future development after we fully evaluate and test the current trial design.

The system requires proper handling of huge amounts of data. Either a huge and fast storage capacity is needed to store the captured signal data, or an enormous computational power is required for the online data processing and filtering. Several hardware approaches currently exist and are in use for the data processing problem handling. Either powerful multi-gigahertz CPUs, GPUs, FPGAs, or specially constructed ASICs are used for this task.

4.1 Custom design of FPGA board

At the beginning of the project, a custom design of FPGA interface board had been considered. This FPGA board should include PCI express interface and should sell at lower price than the trial design. It should be compatible with MLAB internal standards which are further backward compatible with the existing or improved design of ADC modules. For a connection of FPGA board to another adapter board with PCIe, we expect the use of a PCIe host interface. Thunderbolt technology standard was expected to be used in this PC to PCIe module communication, which further talks to MLAB compatible FPGA module. Thunderbolt chips are currently available on the market at a reasonable price [23]. However, a problem lies in the accessibility to their specifications, as they are only available for licensed users and Intel has a mass market oriented licensing policy, that makes this technology inaccessible for low quantity production. As a consequence, the external PCI Express cabling and expansion slots should be considered as a better solution, if we need to preserve standard PC as a main computational platform.

Nevertheless, these PCI express external systems and cables are still very expensive. Opal Kelly XEM6110 [24] is the example. Its price reached 995 USD at the time of writing the thesis. Therefore, a better solution probably needs to be found.

The interface problem will be probably resolved by other than Intel ix86 architecture. Many ARM computers have occurred on the market due to an increased demand for embedded technologies requiring a high computation capacity, low power consumption and small size. The smartphones market is a driving force here. Many of those ARM based systems have interesting signal processing parameters. These facts make Intel's ix86 architecture unattractive for future projects.

4.2 Parallella board computer

Parallella is a new product created by Adapteva, Inc. [25]. It represents a small supercomputer, which has been in development for almost two years with only testing

series of boards produced until now [25]. First single-board computers with the 16-core Epiphany chip were shipped in December 2013 for the first time. The board has nearly ideal parameters for signal processing (as it provides around 50 GFLOPS of the computational power). The board is equipped with Epiphany coprocessor which has 16 High Performance RISC CPU Cores, Zynq-7020 FPGA with Dual ARM® Cortex™-A9 MPCore™ and operating frequency of 866 MHz, 1GB RAM, 85K Logic Cells, 10/100/1000 Ethernet and OpenCL support [26]. In addition to this, the board consumes only 3 Watts of power if both Zynq and Epiphany cores are running simultaneously.

The main disadvantage of Parallella board is its unknown lead time and the absence of SATA interface or other interface suitable for data storage connection. Fast data storage interface would be useful and would allow bulk processing of captured data. Following that, the results of data processing may be sent over the Ethernet interface to the data storage server.

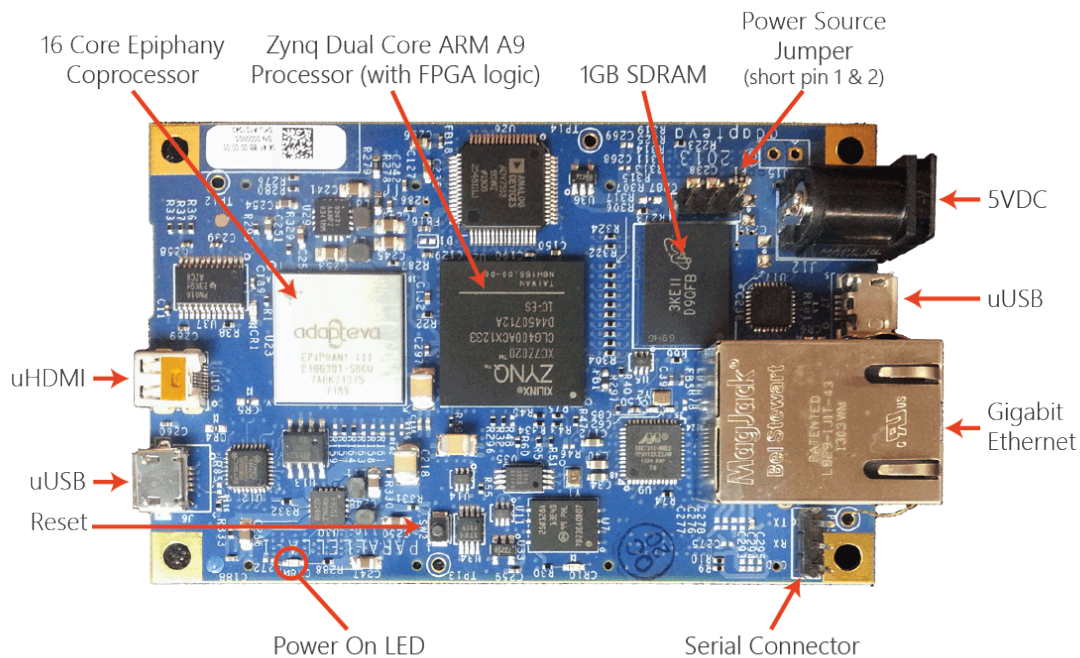

Figure 4.1. Top view on Parallella-16 board [26].

If Parallella board will be used as a radioastronomy data interface, there would be a demand for new ADC interface module. The interface module will use four PEC connectors mounted on the bottom of the Parallella board. This daughter module should have MLAB compatible design and should preferably be constructed in the form of separable modules for every Parallella's PEC connector.

4.3 GPU based computational system

A new GPU development board NVIDIA K1, shown in Figure 4.2, has recently been released. These boards are intended to be used in fields including computer vision, robotics, medicine, security or automotive industry. They have good parameters for signal processing for a relatively low price of 192 USD. Unfortunately, they are currently only in pre-order release stage (in April 2014).

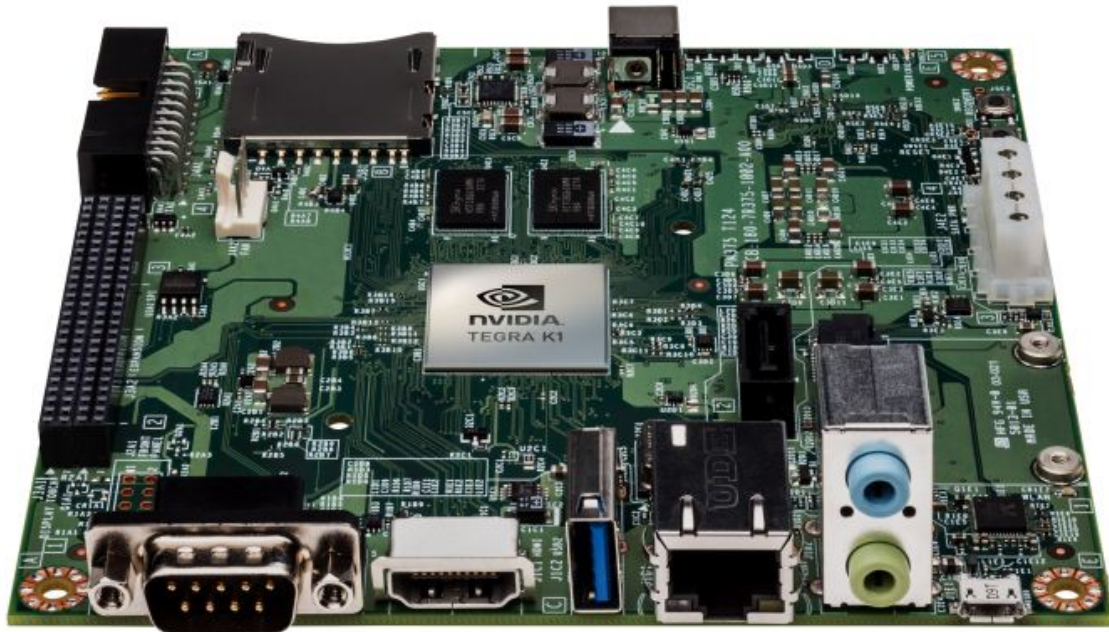

Figure 4.2. The NVIDIA Jetson TK1 Development Kit [27].

NVIDIA board differs from other boards in its category by a presence of PCI Express connector. If we decide to use this development board in our radio astronomy digitalisation system, the PCI express should be used for FPGA connection. A new custom design of FPGA board with Half mini-PCIE direct connector on PCB edge is impractical interface solution due to geometric constrains. Instead of this, the new FPGA module should be designed in standard MLAB fashion and connected to NVIDIA Jetson TK1 via miniHDMI cable. Similar connection solution can be found in source [28].

4.4 Other ARM based computation systems

Other embedded ARM based computers, for example ODROID-XU, lack a suitable high speed interface [29]. Their highest speed interface is USB 3.0 which has currently unsettled development support and needs commercial software tools for evaluation and testing.

From the summary analysis mentioned above, the Parrallella board seems to be the best candidate for the computational board serving the radioastronomy data acquisition system, as it is optimised for high data flow processing. On one hand, Parrallella does not have much memory to cache the processing data but on the other hand it has wide bandwidth data channels instead. Other boards might provide much more computational power – 300 GFLOPS in case of NVIDIA K1, but they are optimised for heavy computational tasks on limited amount of data which represents a typical problem in computer graphics. However, in our application we do not need such extreme computation power at data acquisition system level. As a result, we should presumably wait until Parallella becomes widely available. Following that, a new ADCdual interface board should be designed and prepared to be used in a new scalable radio astronomy data acquisition system. In the meantime, before the suitable computing hardware becomes accessible, the required applications and algorithms should be optimised using

the proposed trial version with FPGA development board on the standard PC host computer (having a PCI Express interface to development board).

Chapter 5

Conclusions

A special design of the scalable data-acquisition system was proposed. This system has unique parameters compared to the state of the art radioastronomy signal processing hardware. The outcome of this diploma project offers the 16bit resolution and such a dynamical range which is not common with others. The conducted experiments demonstrated the system functionality in the instance of the most basic interferometric station. Additional validation of reached parameters would be necessary, though. The fully functional trial version of the fast multi-channel data acquisition part of the radioastronomy receiver was designed and tested in the reported diploma project.

A substantial design and testing experience has been gathered, which will be utilized in the final design aiming at becoming the part of MLAB Advanced Radio Astronomy System [30]. However, additional experimenting is needed.

All requirements demanded by the thesis specification have been reached and/or exceeded. The required minimal sampling frequency of 1 MHz has been exceeded five times at least. The requested dynamical range specified by 12 bits have been exceeded at least by 8 dB in the decibel scale. As a by-pass product of digitization unit design, the software defined GPS disciplined oscillator device has been developed. This device is currently in use in several radio meteor detection stations in the Czech Republic. On other hand the proposed design is not still perfect and some minor imperfections should be corrected in future work.

The work also attracted the interest of the research team at the Czech Technical University in Prague, Faculty of Electrical Engineering in the project MUMOIRE, which has been solved in collaboration and for the US Missile Defense Agency. MUMOIRE team seeks space debris detection/observation methods, which fuse observations from the optical telescope and the radar. The multi-channel data acquisition part of the receiver should provide better radar observations in which French radar GRAVES serves as the energy source.

5.1 Possible hardware improvements

The PCB design of the used modules might need a more precise high-speed optimization of differential pairs. Improvement in the high-speed routing allows a possible use of the fastest ADC from the Linear Technology devices family. The use of the faster ADCs could even improve a range of possible applications.

Minor ADC module imperfections, such as the unnecessary separation of FRAME and DCO signal to two connectors, should be mitigated. These two signals should be merged together to one SATA connector. With this modification, we will be able to remove one redundant SATA cable between the analog to digital converter device and the computational unit section.

■ 5.2 Possible software improvements

In the future versions of the system hardware, the Xillybus IP core and driver interface should be swapped with an open-source alternative of PCIe interfacing module or PCIe might be completely avoided. In ADC configuration FPGA module, the SPI configuration data registers read back should be implemented.



Glossary

ADC – analog-to-digital converter
ALFA – Arecibo L-Band Feed Array
ATA – AT Attachment
CASPER – Collaboration for Astronomy Signal Processing and Electronics Research
CMOS – Complementary metal–oxide–semiconductor
DCO – Data Clock Output
EMI – Electromagnetic interference
FPGA – Field-programmable gate array
GPS – Global Positioning System
GPSDO – GPS disciplined oscillator
HBA – High Band Antenna
HDD – Hard disk drive
IP3 – Third-order intercept point
ISS – International Space Station
LBA – Low Band Antenna
LOFAR – Low-Frequency Array
LVDS – Low-voltage differential signaling
LVPECL – Low Voltage Emitter-coupled logic
MSPS – Mega-Samples Per Second
NASA – National Aeronautics and Space Administration
PCB – printed circuit board
PCI Express – Peripheral Component Interconnect Express
PVC – Polyvinyl chloride
RF – Radio frequency
ROACH – Reconfigurable Open Architecture Computing Hardware (ROACH) board
SATA – Serial ATA
TV – Television
USB 2.0 – Universal Serial Bus version 2.0
USRP – Universal Software Radio Peripheral
WWII – Second World War



References

- [1] UKARANet. Radio astronomy frequency allocations, May 2014.
http://www.ukaranet.org.uk/basics/frequency_allocation.htm.
- [2] Kortánek Jiří. Radioteleskop JOVE, přijímač ruchů z jupiterových radiových bouří, bakalářská práce 000672041, September 2007.
https://aleph.cvut.cz:443/F?func=direct&doc_number=000672041&local_base=DUPL&format=999.
- [3] A National Instruments Company Ettus Research. URSP series products, 2013.
<https://www.ettus.com/product/category/USRP-X-Series>.
- [4] Michael Ossmann. HackRF one an open source SDR platform, 2013.
<http://greatscottgadgets.com/hackrf/>.
- [5] M. P. van Haarlem and et. al. *LOFAR: The LOw-Frequency ARray*, May 2013.
<http://arxiv.org/abs/1305.3550>.
- [6] Astron. Design and development, May 2014.
http://www.astron.nl/other/desp/competences_DesApp.htm.
- [7] Microsoft. Microsoft spectrum observatory, 2012.
<http://observatory.microsoftspectrum.com/>.
- [8] Chris Salter Fernando Camilo, Robert Minchin. *ALFA: Arecibo L-Band Feed Array*, May 2012.
<http://www.naic.edu/alfa/>.
- [9] Univeristy of California Berkeley. Center for astronomy signal processing and electronics research, May 2014.
<https://casper.berkeley.edu/>.
- [10] Univeristy of California Berkeley. A new approach to radioastronomy signal processing, May 2014.
<https://casper.berkeley.edu/papers/200509URSI.pdf>.
- [11] Digikey. 6367550-5-nd, May 2014.
<http://www.digikey.com/product-detail/en/6367550-5/6367550-5-ND/2259130>.
- [12] Fringe Dwellers. Simple interferometer, May 2004.
<http://fringes.org/>.
- [13] Pieter-Tjerk de Boer. PA3FWM's software defined radio page, April 2013.
<http://wwwhome.cs.utwente.nl/~ptdeboer/ham/sdr/>.
- [14] J. Kakona and M. Kakona. Software defined gps disciplined oscillator - gpsdo01a, January 2014.
<http://wiki.mlab.cz/doku.php?id=en:gpsdo>.
- [15] Silicon Laboratories. *Si570 datasheet*, January 2014.
<http://www.silabs.com/Support%20Documents/TechnicalDocs/si570.pdf>.

- [16] Robert LeBoeuf. Data converter serial lvds interface improves board routing, snaa110, January 2011.
<http://www.ti.com/lit/wp/snaa110/snaa110.pdf>.
- [17] Inc Micrel. *SY55855V datasheet*, November 2005.
http://www.micrel.com/_PDF/HBW/sy55855v.pdf.
- [18] Inc Micrel. *SY55857L datasheet*, August 2006.
http://www.micrel.com/_PDF/HBW/sy55857l.pdf.
- [19] Ondřej Sychrovský. Connecting an FMC with attached A/D converters – middleware for an FPGA board, ctu-cmp-2014-5, May 2014.
<ftp://cmp.felk.cvut.cz/pub/cmp/articles/sychrovsky/Sychrovsky-TR-2014-05.pdf>.
- [20] MLAB. Softwarově definovaný přijímač MLAB SDRX, May 2014.
<svn://svn.mlab.cz/MLAB/Designs/HAM%20Constructions/SDRX02B>.
- [21] Inc. Agilent Technologies. *33220A Function / Arbitrary Waveform Generator, 20 MHz*, December 2011.
http://www.home.agilent.com/agilent/redirector.jspx?action=obs&nid=536883183.3.00&lc=eng&cc=CZ&ckey=187648&pubno=5988-8544EN<ype=LitStation&ctype=AGILENT_EDITORIAL&ml=eng.
- [22] MLAB. Radio meteor detection station, May 2014.
<http://wiki.mlab.cz/doku.php?id=cs:rmds02>.
- [23] Intel Mouser. Dsl2210, January 2014.
http://cz.mouser.com/search/Refine.aspx?Keyword=106790692&Ns=Pricing|0&FS=True&Ntk=P_MarCom.
- [24] Opal Kelly. Opal kelly xem6110, January 2011.
<http://www.opalkelly.com/products/xem6110/>.
- [25] Adapteva. Parallella - supercomputing for everyone, January 2014.
<http://www.parallella.org/board/>.
- [26] Adapteva. Parallella-16, April 2014.
<http://shop.adapteva.com/collections/featured-products/products/parallella-16>.
- [27] NVIDIA. The NVIDIA jetson TK1 development kit, April 2014.
<https://developer.nvidia.com/jetson-tk1>.
- [28] Dan Strother. FMC-LPC to SATA adapter board, April 2010.
<http://danstrother.com/2010/12/04/fmc-lpc-to-sata-adapter-board/>.
- [29] MLAB. Procesory architektury ARM ve stavebnici MLAB, May 2014.
<http://wiki.mlab.cz/doku.php?id=cs:arm>.
- [30] Jakub Kákona MLAB. Pokročilá radioastronomická stanice ARAS01A, Sep 2013.
<http://wiki.mlab.cz/doku.php?id=cs:aras>.

Appendix A

Circuit diagram of ADCdual01A module

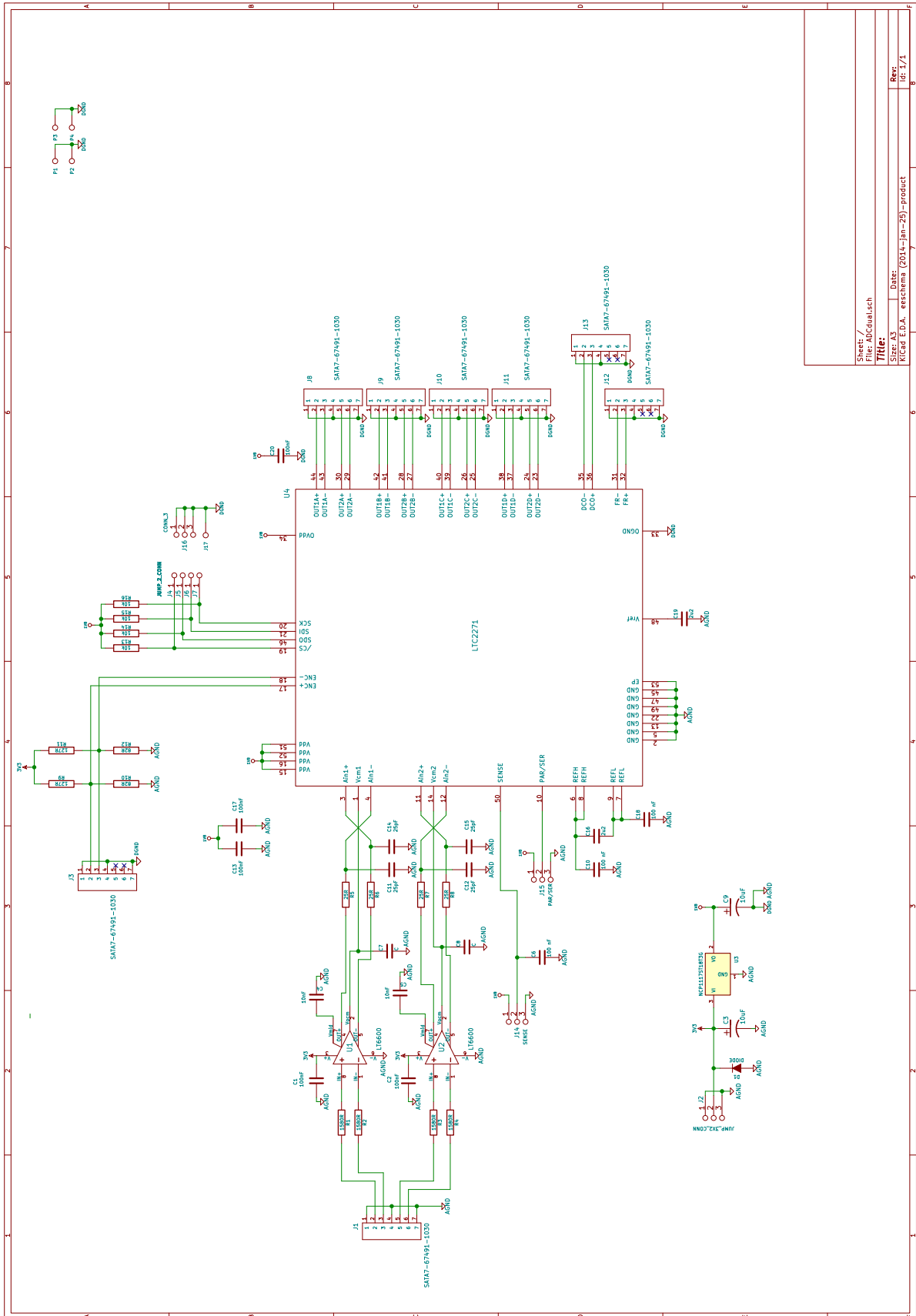

Sheet /	File: ADCdual1.sch
Title:	
Size: A3	Date: eschema (2014-jan-25)-product
Rev: 08-1/1	

Appendix B

Circuit diagram of FMC2DIFF module

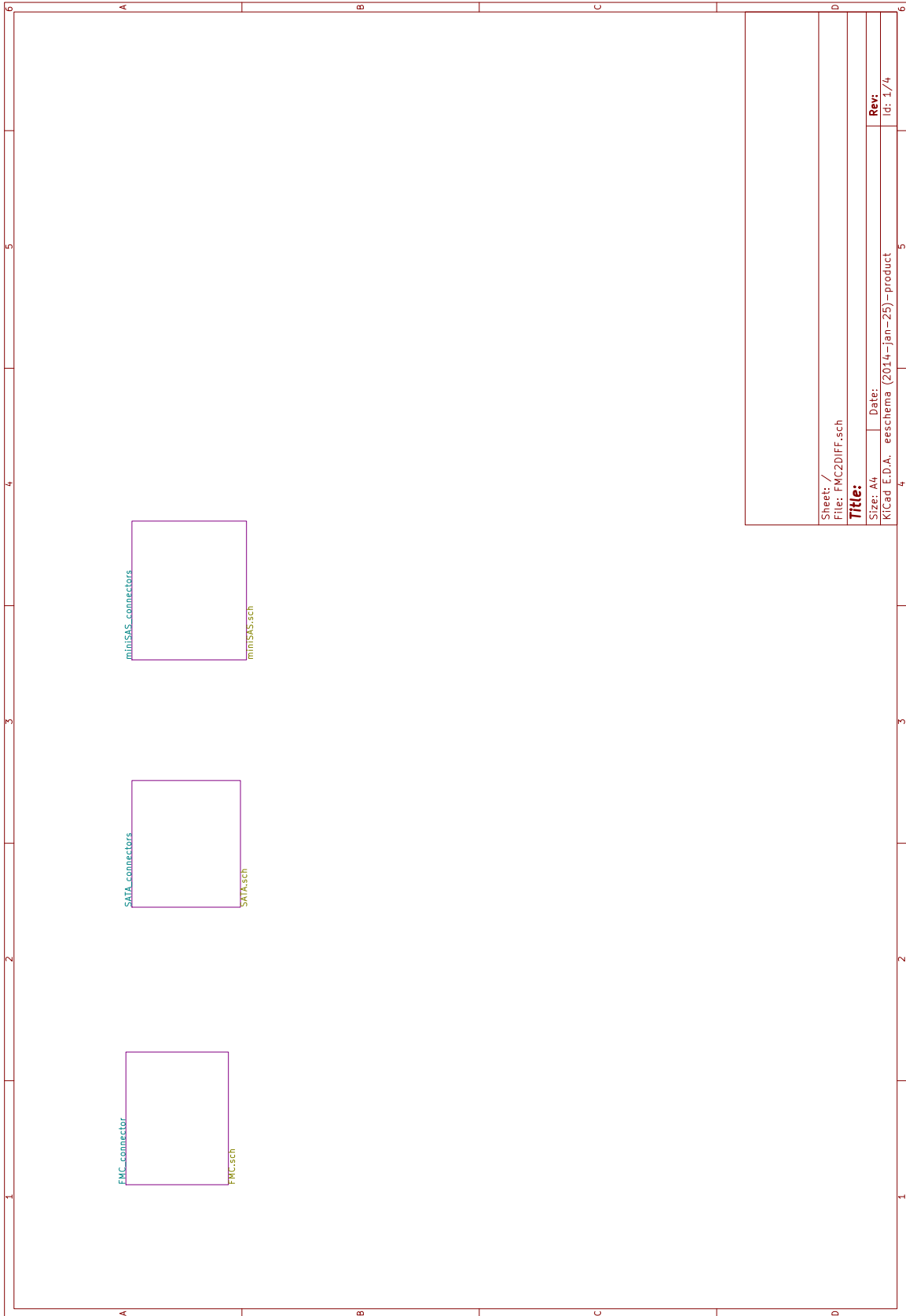

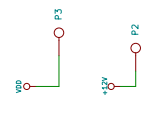
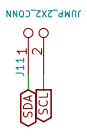
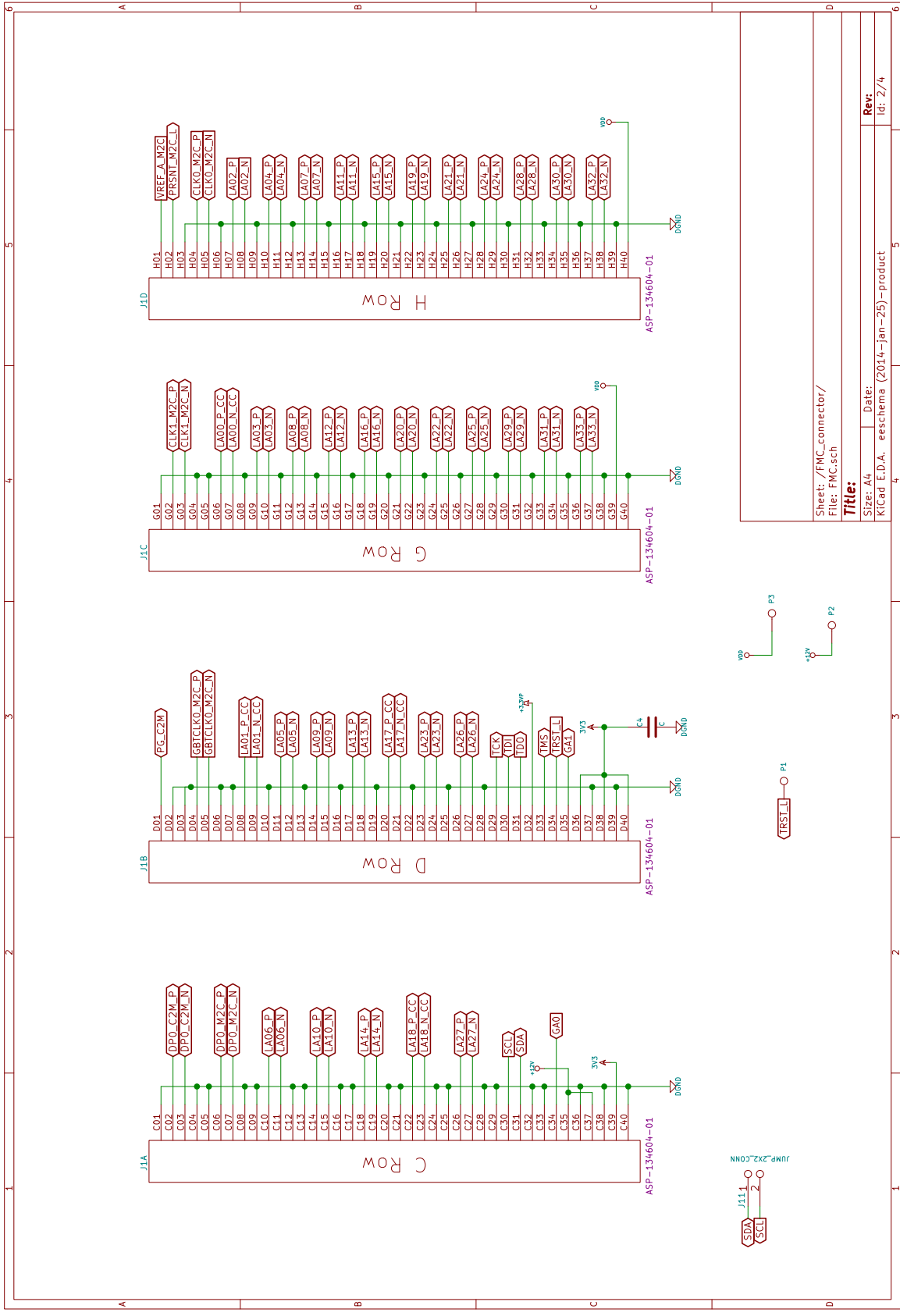

B Circuit diagram of FMC2DIFF module

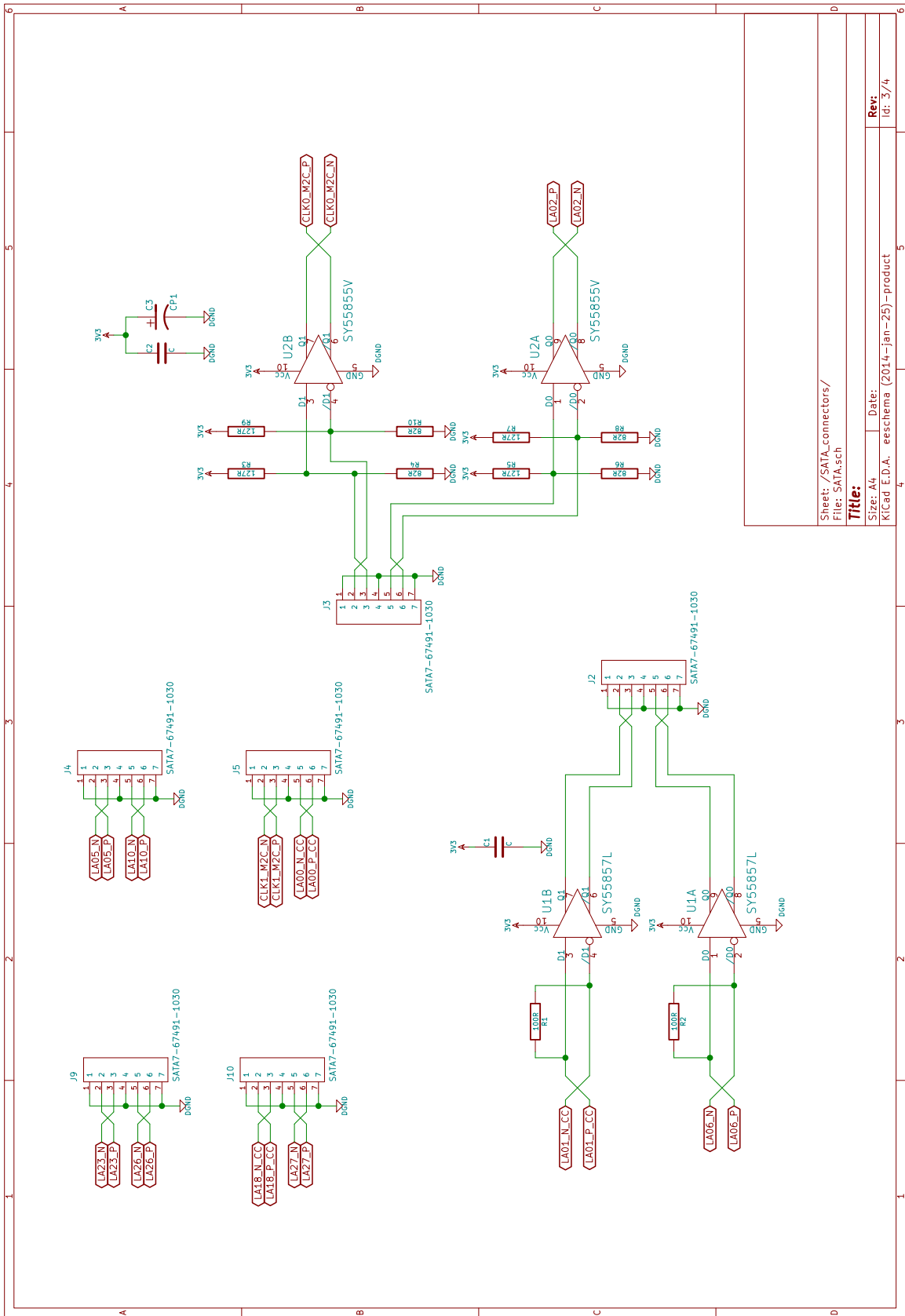

Sheet: /SATA_connectors/
File: SATA.sch

Title:

Size: A4

Date:

K\Cad_E.D.A. eeschema (2014-jan-25) - product

Rev:

Id: 3/4

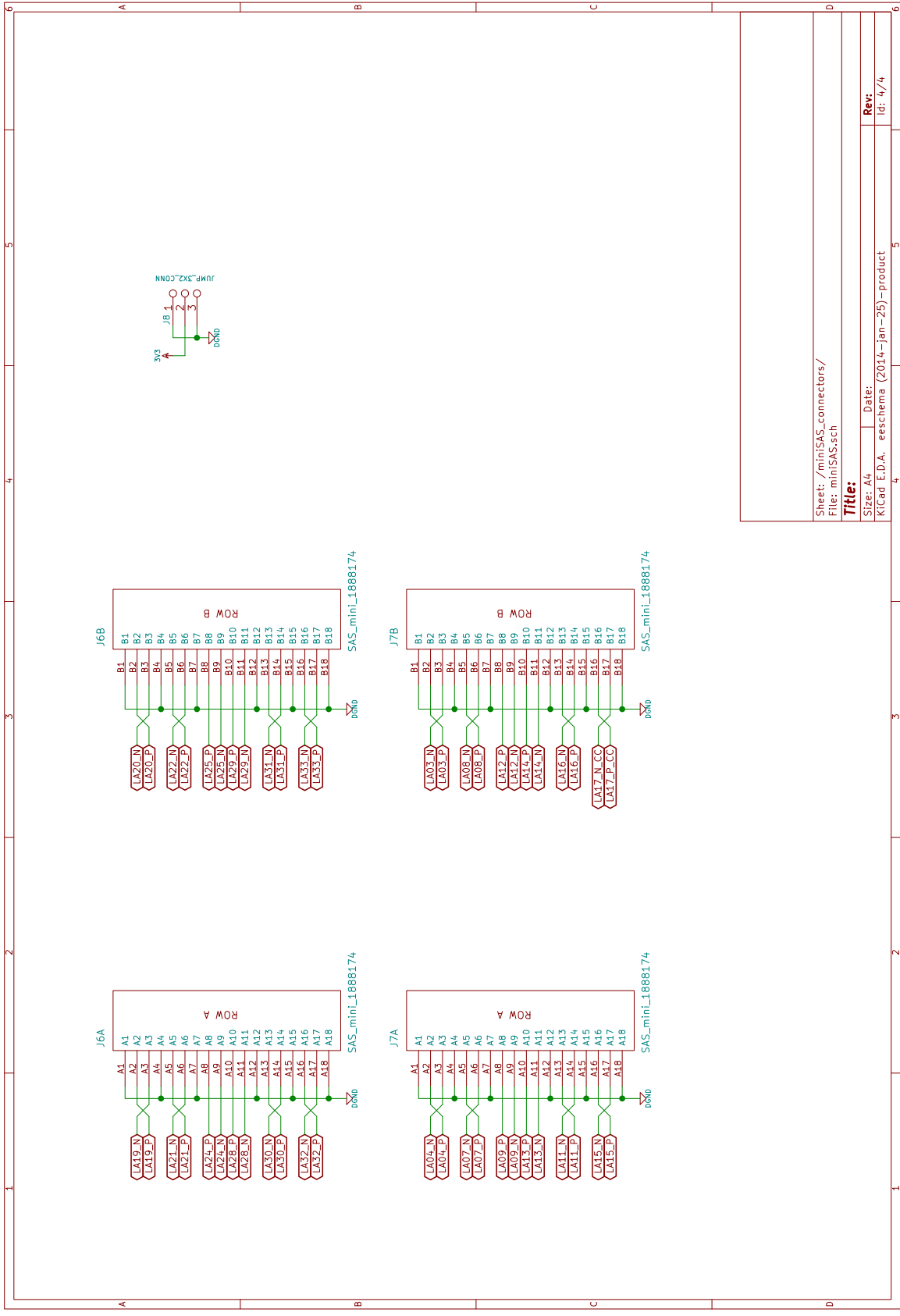

Sheet: /miniSAS_connectors/
File: miniSAS.sch

Title:

Size: A4 Date: eeschema (2014-jan-25) - product
Id: 4/4



Appendix C

Content of enclosed CD

- Thesis source code.
- Measured data set from interferometric station.
- Installation file of gnuradio in version used in the work.
- GRC flow-graphs.
- Used datasheets.
- Photographs from development and testing.
- Source files for designed PCB modules.