

D:

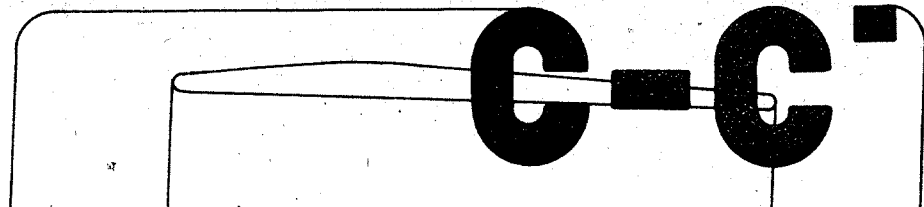

ZENY
(RICHTIG AUSGEWEN)

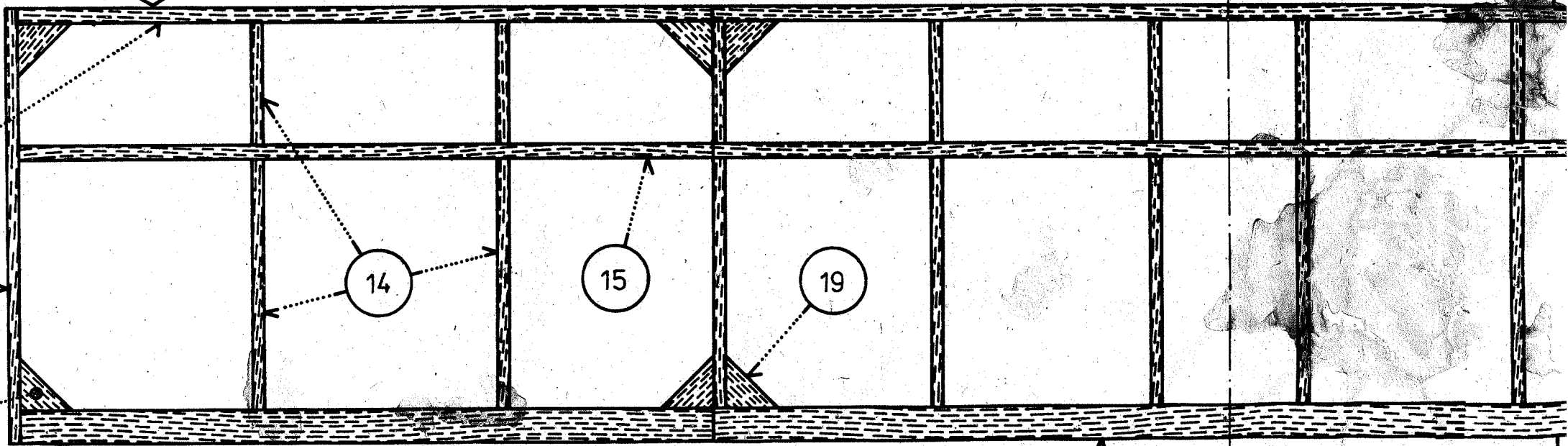
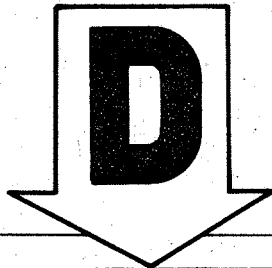
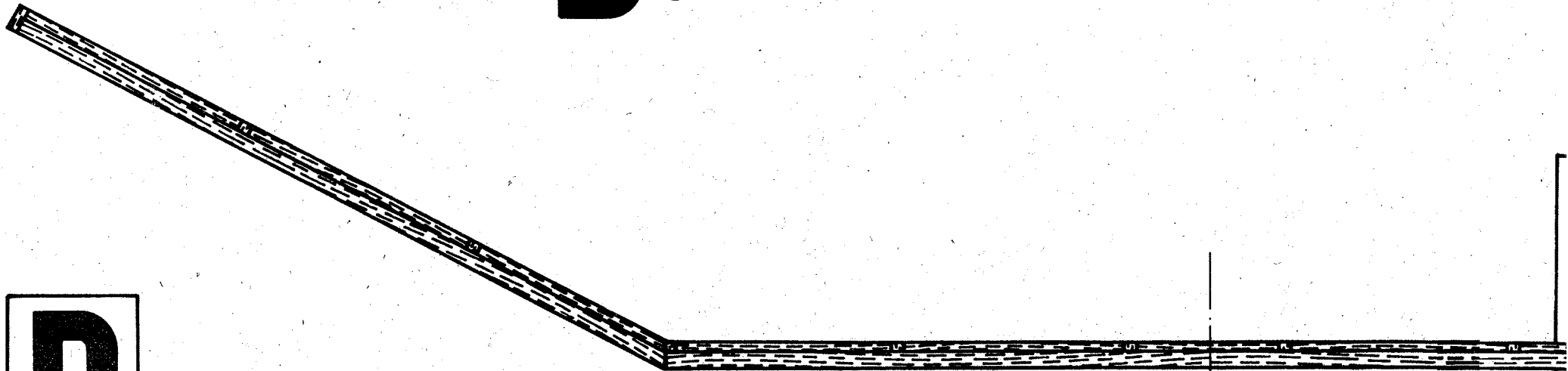
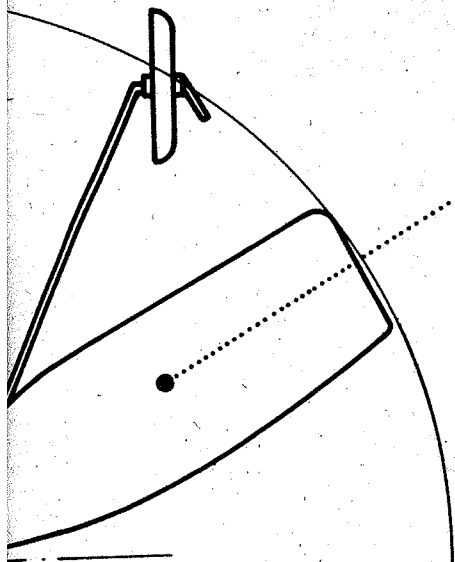
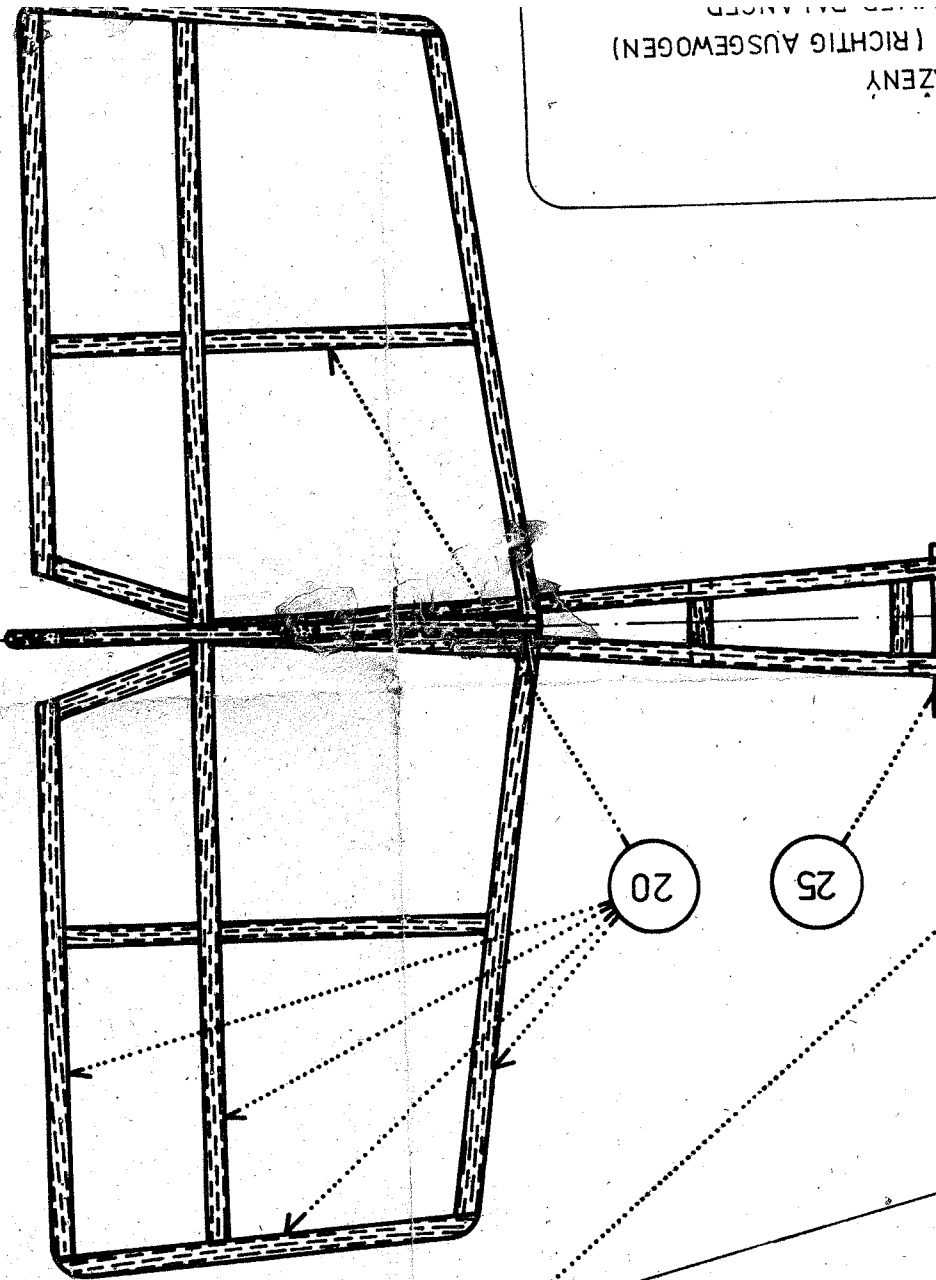
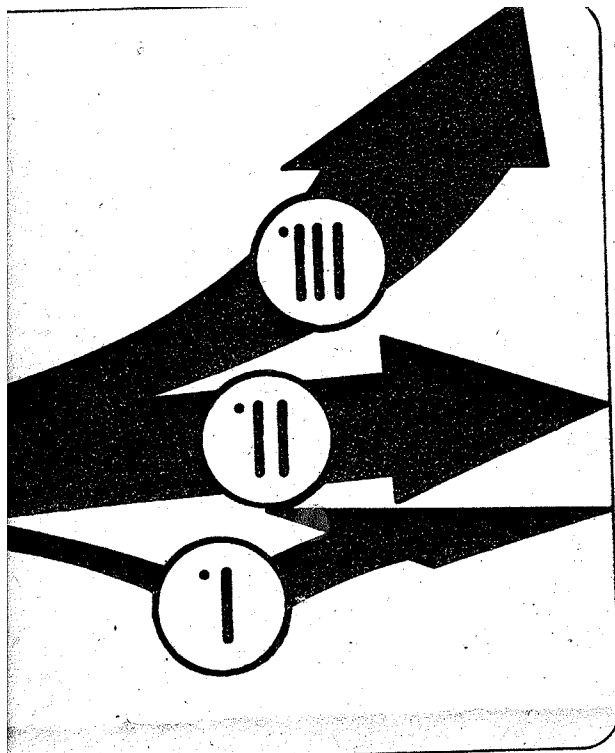

13

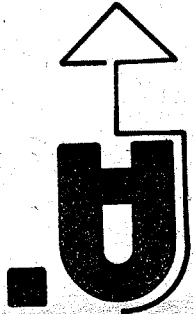

20

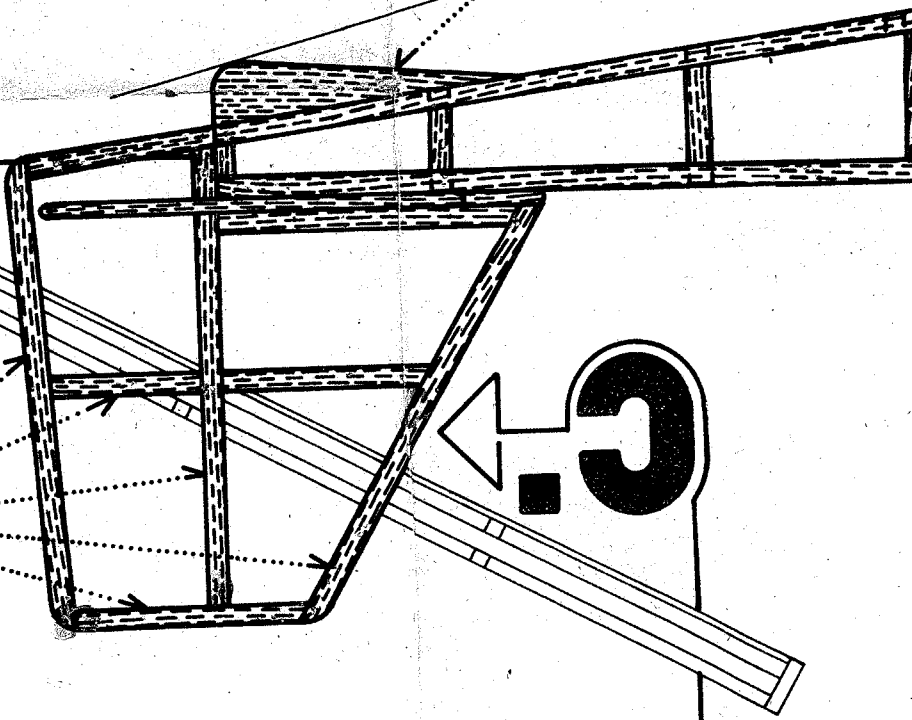

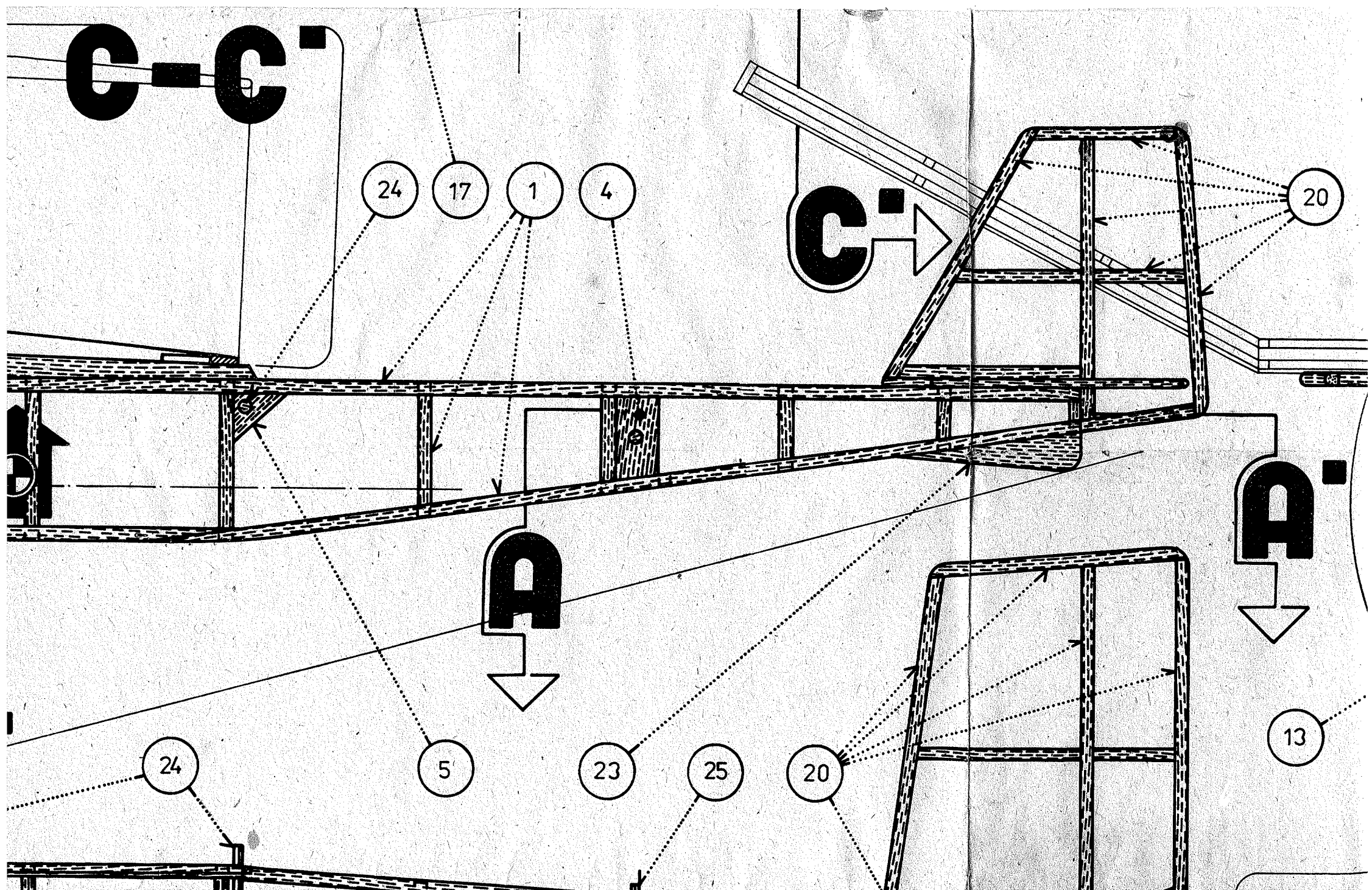

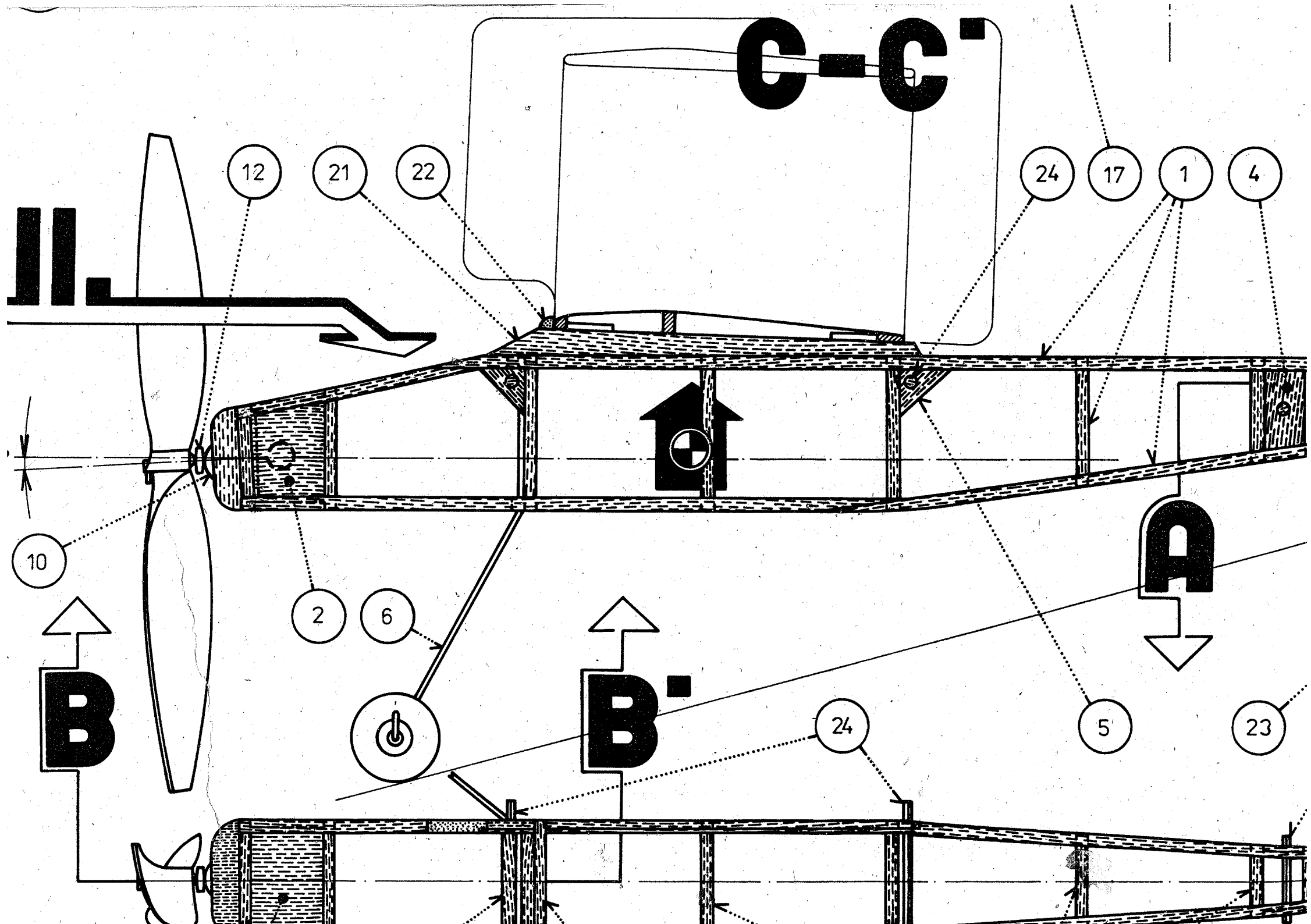

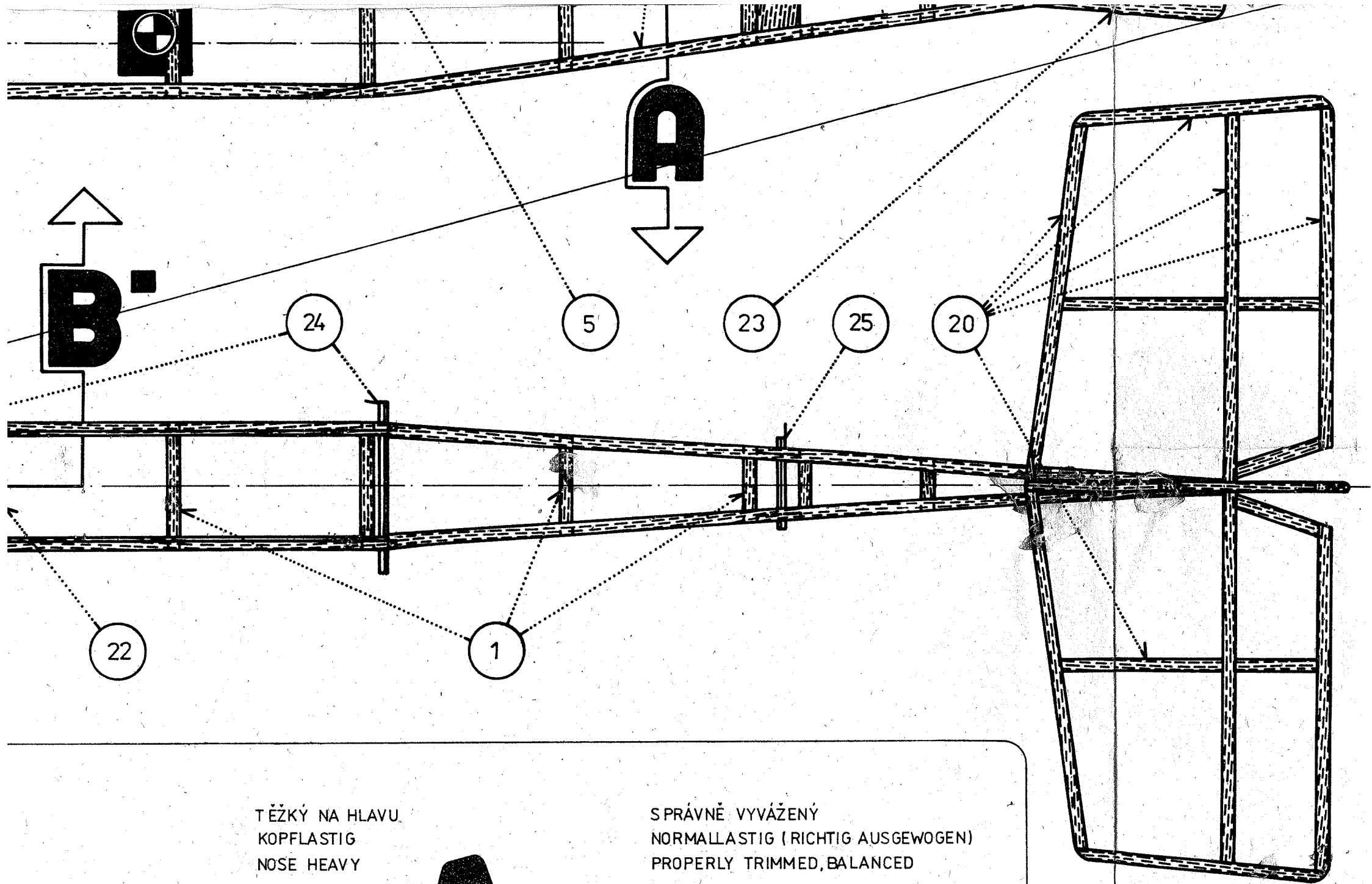

TĚŽKÝ NA HLAVU.
KOPFLASTIG
NOSE HEAVY

SPRÁVNĚ VYVÁŽENÝ
NORMALLASTIG (RICHTIG AUSGEWOGEN)
PROPERLY TRIMMED, BALANCED

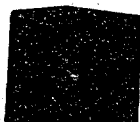
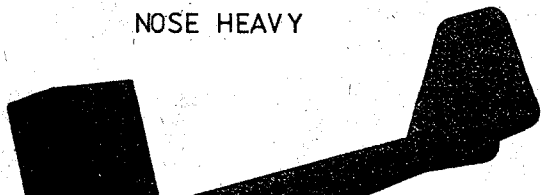

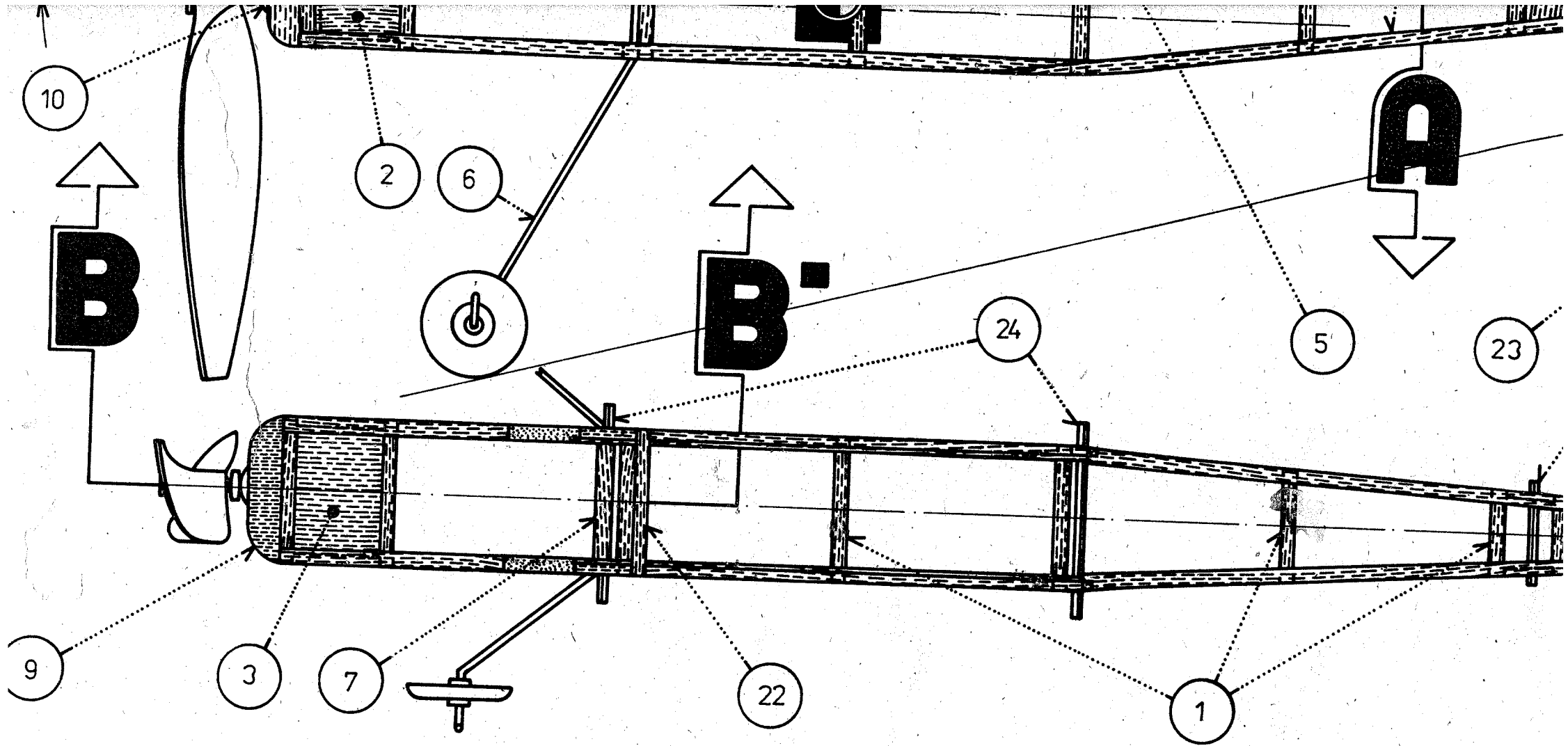

IV.

TĚŽKÝ NA OCAS
 SCHWANZLASTIG
 TAIL HEAVY

TĚŽKÝ NA HLAVU
 KOPFLASTIG
 NOSE HEAVY

SPRÁVNĚ VYVÁŽENÝ
 NORMALLASTIG (RICHTIG)
 PROPERLY TRIMMED.

